



# **Built-In Ceramic Cooktop Manual**

**EMPV-24REC11**

**Designed and Engineered in USA**

**Distributed by Empava Appliances Inc.**

**Add: 15253 Don Julian Road, City of Industry, CA, 91745 USA**

**Tel:(888)682-8882**

**WWW.EMPAVA.COM**



# **CONTENTS:**

**Part 1. Safety Warnings**

**Part 2. Installation**

**Part 3. Operation Instructions**

**Part 4. Cleaning and Maintenance**

**Congratulations** on the purchase of your new cooktop and thank you for choosing us!

**Please read all instructions carefully before use.**

# Part 1. Safety Warnings

## Safety Warnings

**Your safety is important to us. Please read below information carefully before installing or using your Cooktop.**

**Important – Save for the local electrical inspector’s use.**

To eliminate the risk of burns or fire by reaching over heated surface units, cabinet storage space located above the surface units should be avoided. If cabinet storage is to be provided, the risk can be reduced by installing a range hood that projects horizontally a minimum of 5 inches beyond the bottom of the cabinets.

## Installation

### Electrical Shock Hazard

- Disconnect the appliance from the mains electricity supply before carrying out any work or maintenance on it.
- Connection to a good earth wiring system is essential and mandatory.

- Alterations to the domestic wiring system must only be made by a qualified electrician.
- Failure to follow this advice may result in electrical shock or death.

## **Cut Hazard**

- Take care - panel edges are sharp.
- Failure to use caution could result in injury or cuts.

## **Important safety instructions**

- Read these instructions carefully before installing or using this appliance.
- No combustible material or products should be placed on this appliance at any time.
- Please make this information available to the person responsible for installing the cooktop as it could reduce your installation costs.
- In order to avoid a hazard, this appliance must be installed according to these instructions for installation.
- This appliance is to be properly installed and earthed only by a suitably qualified person.
- This appliance should be connected to a circuit which incorporates an isolating switch

providing full disconnection from the power supply.

- Failure to install the appliance correctly could invalidate any warranty or liability claims.

## **Operation and maintenance**

### **Electrical Shock Hazard**

- Do not cook on a broken or cracked cooktop. If the cooktop surface should break or crack, switch the appliance off immediately at the mains power supply (wall switch) and contact a qualified technician.
- Switch the cooktop off at the wall before cleaning or maintenance.
- Failure to follow this advice may result in electrical shock or death.

### **Health Hazard**

- This appliance complies with electromagnetic safety standards.
- However, persons with cardiac pacemakers or other electrical implants (such as insulin pumps) must consult with their doctor or implant manufacturer before using this

appliance to make sure that their implants will not be affected by the electromagnetic field.

- Failure to follow this advice may result in death.

## **Hot Surface Hazard**

- During use, accessible parts of this appliance will become hot enough to cause burns.
- **DO NOT TOUCH SURFACE UNITS OR AREAS NEAR UNITS** – Surface units may be hot even though they are dark in color. Areas near surface units may become hot enough to cause burns. During and after use, do not touch, or let clothing or other flammable materials contact surface units or areas near units until they have had sufficient time to cool. Among these areas are (identification of areas – for example, the cook-top and surfaces facing the cook-top).
- Do not let your body, clothing or any item other than suitable cookware contact the ceramic glass until the surface is cool.
- **Wear Proper Apparel** – Loose-fitting or hanging garments should never be worn while

using the appliance.

- Beware: Metallic objects such as knives, forks, spoons and lids should not be placed on the cooktop surface since they can get hot.
- Storage in or on Appliance – Flammable materials should not be stored or near surface units.
- Keep children away.
- Handles of saucepans may be hot to touch. Check saucepan handles do not overhang other cooking zones that are on. Keep handles out of reach of children.
- Utensil Handles Should Be Turned Inward and Not Extend Over Adjacent Surface Units – To reduce the risk of burns, ignition of flammable materials, and spillage due to unintentional contact with the utensil, the handle of a utensil should be positioned so that it is turned inward, and does not extend over adjacent surface units.
- Failure to follow this advice could result in burns and scalds.

## **Cut Hazard**

- The razor-sharp blade of a cooktop scraper is exposed when the safety cover is retracted.

Use with extreme care and always store safely and out of reach of children.

- Failure to use caution could result in injury or cuts.

## **Important safety instructions**

- Never leave the appliance unattended when in use. Boil over causes smoking and greasy spillovers that may ignite.
- Never use your appliance as a work or storage surface.
- Never leave any objects or utensils on the appliance.
- Do not place or leave any magnetisable objects (e.g. credit cards, memory cards) or electronic devices (e.g. computers, MP3 players) near the appliance, as they may be affected by its electromagnetic field.
- Make Sure Reflector Pans or Drip Bowls Are in Place – Absence of these pans or bowls during cooking may subject wiring or components underneath to damage.
- Never use your appliance for warming or heating the room.
- After use, always turn off the cooking zones and the cooktop as described in this manual.



Do not rely on the pan detection feature to turn off the cooking zones when you remove the pans.

- Do not allow children to play with the appliance or sit, stand, or climb on it.
- Do not store items of interest to children in cabinets above the cooktop. Children climbing on the cooktop could be seriously injured.
- Do not leave children alone or unattended in the area where the appliance is in use. They should never be allowed to sit or stand on any part of the appliance.
- Children or persons with a disability which limits their ability to use the appliance should have a responsible and competent person to instruct them in its use. The instructor should be satisfied that they can use the appliance without danger to themselves or their surroundings.
- Do not repair or replace any part of the appliance unless specifically recommended in the manual. All other servicing should be done by a qualified technician.
- Do not use steam cleaner to clean cooktop.
- Clean Cook-Top With Caution – If a wet sponge or cloth is used to wipe spills on a hot

cooking area, be careful to avoid steam burn. Some cleaners can produce noxious fumes if applied to a hot surface.

- Do not place or drop heavy objects on cooktop.
- Do not stand on your cooktop.
- Do not use pans with jagged edges or drag pans across the ceramic glass surface as this can scratch the glass.
- Do not use scourers or any other harsh abrasive cleaning agents to clean your cooktop, as these can scratch the ceramic glass.
- Do Not Use Water on Grease Fires – Smother fire or flame or use dry chemical or foam-type extinguisher.
- Protective Liners – Do not use aluminum foil to line surface unit drip bowls or oven bottoms, except as suggested in the manual. Improper installation of these liners may result in a risk of electric shock, or fire.
- Do Not Soak Removable Heating Elements – Heating elements should never be immersed in water.
- If the power supply cable is damaged, it must only be replaced by qualified technician.

- This appliance is intended to be used in household and similar applications such as:
  - staff kitchen areas in shops, offices and other working environments;
  - farm houses;
  - by clients in hotels, motels and other residential type environments;
  - bed and breakfast type environments.
- Use Proper Pan Size – This appliance is equipped with one or more surface units of different size. Select utensils having flat bottoms large enough to cover the surface unit heating element. The use of undersized utensils will expose a portion of the heating element to direct contact and may result in ignition of clothing. Proper relationship of utensil to burner will also improve efficiency.
- Glazed Cooking Utensils – Only certain types of glass, glass/ceramic, ceramic, earthenware, or other glazed utensils are suitable for range-top service without breaking due to the sudden change in temperature.
- This appliance can be used by children aged from 8 years and above and persons with reduced physical, sensory or mental

capabilities or lack of experience and knowledge if they have been given supervision or instruction concerning use of the appliance in a safe way and understand the hazards involved. Children shall not play with the appliance. Cleaning and user maintenance shall not be made by children without supervision.

- **WARNING:** Unattended cooking on a cooktop with fat or oil can be dangerous and may result in fire. NEVER try to extinguish a fire with water, but switch off the appliance and then cover flame e.g. with a lid or a fire blanket.

**Please save this instructions for future reference.**

## **Part 2. Installation**

### **Installation Instructions**

**The appliance must be installed and connected in accordance with current regulations.**

**After unpacking the appliance, ensure there is no visible damage. If it has been damaged during transit, DO NOT USE, contact where you buy immediately.**

## Selection of installation equipment

-Cut out the work surface according to the sizes shown in the drawing.

**-For the purpose of installation and use, a minimum of 5 cm space shall be preserved around the hole.**

**-Be sure the thickness of the work surface is at least 30mm. Please select heat-resistant work surface material to avoid larger deformation caused by the heat radiation from the hotplate. As shown below (measure by unit: inch):**

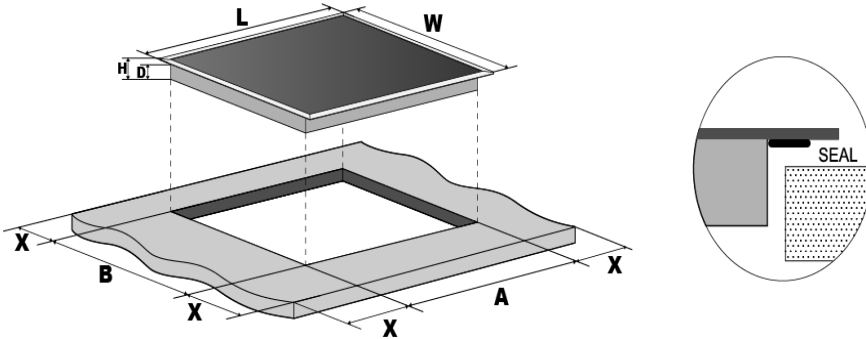

Model	L	W	H	D	A	B	X
EMPV-24REC11	23.2	20.5	2.1	1.9	21.9+0.2 -0	19.5+0.2 -0	2.0 min

Under any circumstances, make sure the electric cooktop is well ventilated and the air inlet and outlet are not blocked. Ensure the electric cooktop is in good work state. As shown below:



Note: The safety distance between the hotplate and the cupboard above the hotplate should be at least 29.9 inches.

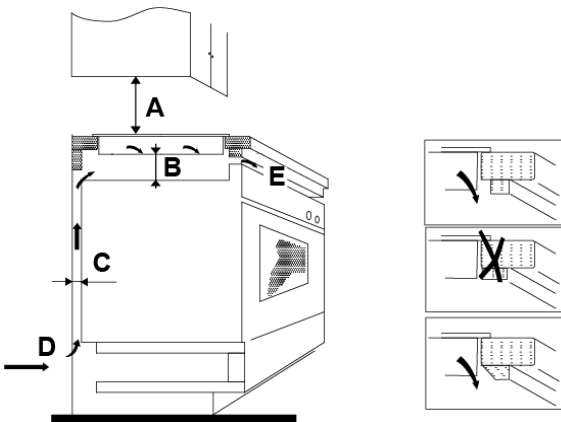

A(in.)	B(in.)	C(in.)	D	E
29.9	2.0 minimal	0.8 minimal	Air intake	Air exit 0.2

## Installing the foam gasket

Before inserting the cooktop into the opening in the kitchen worktop, the supplied foam gasket (in a plastic bag) must be attached to the lower side of the ceramic glass.

**Do not install the cooktop without the foam gasket!**

**The gasket should be attached to the cooktop in the following method:**

- Remove the protective film from the gasket.
- Then attach the gasket to the lower side of the glass, next to the edge.
- The gasket must be attached along the entire length of the glass edge and should not overlap at the corners.
- When installing the gasket, make sure that the glass does not come into contact with any sharp objects.

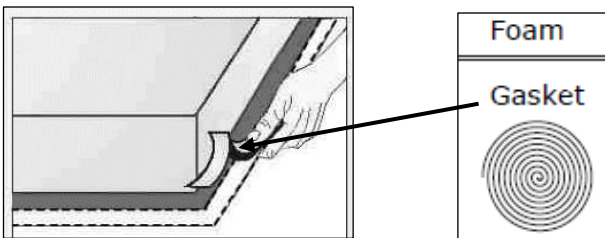

## Before locating the fixing brackets

The unit should be placed on a stable, smooth surface (use the packaging). Do not apply force onto the controls protruding from the cooktop.

### Easy Fit kits

There is one easy fit kits package for each cooktop, include fixing clips and screws(total 2pcs clip and 2pcs screw). Find the easy fit kit package first.

**Fix clips to cooktop:** Insert the fixing clips into fixing holes reserved on 2 sides

of housing, fix clip to housing with screw, then insert cooktop into cabinet/work surface.

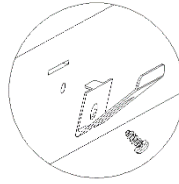
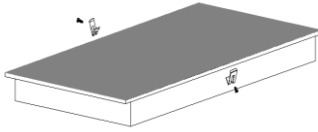

**Fix cooktop to cabinet:** Insert the cooktop into the cabinet/work surface as below diagrams, the mounted clips on the sides can secure your cooktop sturdily.

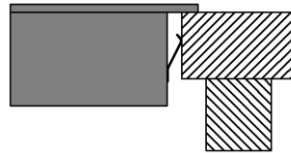
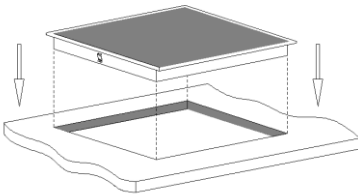

## Connecting the cooktop to the mains power supply

The power supply should be connected in compliance with the relevant standard, or a single-pole circuit breaker. **The appliance has a large power rating and must be connected to electricity by a Qualified Electrician.**

### Notes:

1. If the cable is damaged or needs replacing, this should be done by an after-sales technician using the proper tools, so as to avoid any accidents.
2. If the appliance is being connected directly to the mains supply, an omni polar circuit breaker must be installed with a minimum gap of 3mm between the contacts.
3. The installer must ensure that the correct electrical connection has been made and that it complies with safety regulations.
4. The cable must not be bent or compressed.
5. The cable must be checked regularly and only replaced by qualified technician.

## Cautions

1. **The cooktop must be installed by qualified personnel or technicians.** Please never conduct the operation by yourself.
2. The electric cooktop shall not be mounted to cooling equipment, dishwashers and rotary dryers.
3. The electric cooktop shall be installed such that better heat radiation can be

- ensured to enhance its reliability.
4. The wall and induced heating zone above the work surface shall withstand heat.
  5. To avoid any damage, the sandwich layer and adhesive must be heat resistant.
  6. A steam cleaner is not to be used.
  7. This electric cooktop can be connected only to a supply with system impedance no more than 0.427 ohm. In case necessary, please consult your supply authority for system impedance information.

**Note: For some of the models, there might applied with a power cord with plug. If so, you can directly plug in socket. Please keep power cord plug out after use.**

**For those model power cord without plug, the method of connections shown below.**

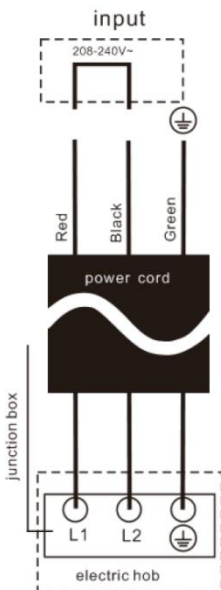



# Part 3. Operation Instructions

## Model: EMPV-24REC11

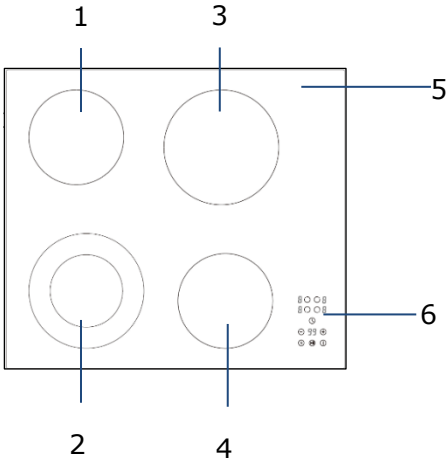

1. 1200W Cooking Zone
2. 2200/1000W Cooking Zone
3. 1800W Cooking Zone
4. 1200W Cooking Zone
5. Glass plate
6. Control panel

### Control Panel

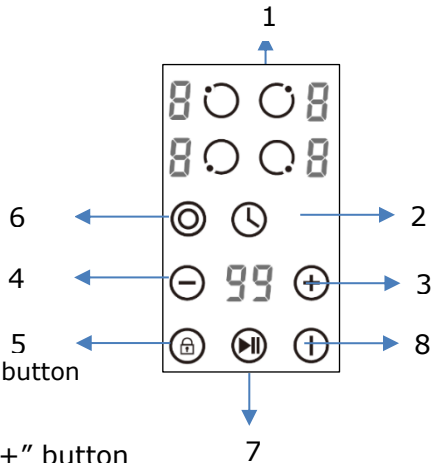

1. Cooking Zone selection button
2. Timer control button
3. Heating level/Timer "+" button
4. Heating level/Timer "-" button
5. Child Lock control button
6. Extended zone control button
7. Stop & Go control button
8. ON/OFF button

**Notes: Product diagrams in the manual for reference only, there might be slightly difference due to continually product improvements.**

## Before using your New Cooktop

- Read this guide, taking special note of the 'Safety Warnings' section.
- Remove any protective film that may still be on your new electric cooktop.

## Using the Touch Controls

- The controls respond to touch, so you don't need to apply any pressure.
- Use the ball of your finger, not its tip.
- You will hear a beep each time a touch is registered.
- Make sure the controls are always clean, dry, and that there is no object (e.g. a utensil or a cloth) covering them. Even a thin film of water may make the controls difficult to operate.

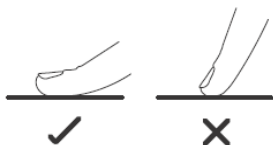

## Choose the right Cookware



Do not use cookware with jagged edges or a curved base.



Make sure that the base of your pan is smooth, sits flat against the glass, and is the same size as the cooking zone. If you use smaller pot efficiency could be less than expected. Always centre your pan on the cooking zone.

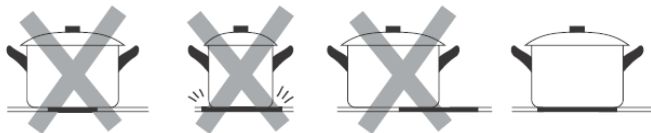

Always lift pans off the cooktop – do not slide, or they may scratch the glass.

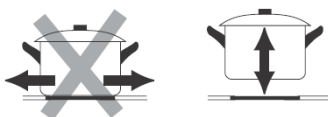

**Notes:** You can use any kind of pot or pan for Ceramic Cooktop.

# Using your Cooktop

## To start cooking

1. After the cooktop be connected to electricity and power on.

**Press and hold the ON/OFF  control button for about 3 seconds till you hear a "beep" to turn the cooktop on.** Now the cooktop enters into Standby mode, all heat setting indicators and Timer setting indicators shows "-"



2. Place a suitable pan on the cooking zone you wish to use.

- Make sure the bottom of the pan and the surface of the cooking zone are clean and dry.

3. Set heating level of cooking zone

**Before adjust heating level, need to touch the heating zone selection control button to select and active the cooking zone you wish to use.**

The heat setting indicator of the selected zone flashing when be active, then you could adjust its heat level by below:

- Set heat setting by touching the  or  button.
- If press and hold either of the two buttons, the value will adjust down or up rapidly, from 0 to 9 in circle.

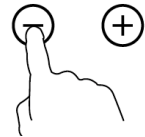
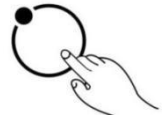
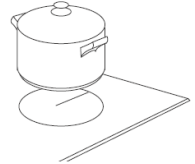
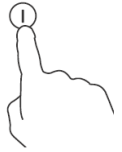

## Notes:

1. After connect to electricity, when power on, the buzzer of cooktop beeps once, all indicators light up for 1 second then go out.
2. When the cooktop in Standby mode, if there is no practice within 1 minute, the electric cooktop will auto turn off, with buzzer beeps once.
3. To turn on cooktop, press the ON/OFF button and hold on for about 3 seconds; To turn it off, just need to press ON/OFF button again.
4. The power level can be adjusted from 0 to 9, default setting is level 5.
5. The heat setting indicator of the selected zone flashing when adjusting. After adjusting, the number flashing for 5 seconds then stop flashing, then the setting is be confirmed.

## To turn off cooktop

1. You can turn the cooking zone off by adjust heat setting to level 0, which indicator shows "-".

2. You can also turn the whole cooktop off by touching the ON/OFF  control button.



**Note:** If there is power cut off during cooking, all setting will be cancelled.

**Note:** The cooling fan of induction cooktop will remain on for about 1 minute after the cooktop be turned off.

## Using Large Heating Area-Ceramic Cooktop

Some of **ceramic cooktop** models might have one or several extended cooking zones (Oval/Dual/Triple zone), these extended zones can provide larger cooking area and additional heat to fit for different size of cooking pan.

**To use Extended zone when cooktop is working, follows below:**

1. Select and active the cooking zone which you would like to use extended zones, for those cooking zone with this feature. Touch the heating zone selection control button to select and active it for adjustment.
2. The central zone will be switched on, when first adjust of heat level for extended cooking zone.
3. When the heating zone be selected and active (power level indicator flashing), touch extended zone control button  to active extended heating element to get a large heating area.



**Notes:**

1. By continuous touch the control button, the extended zones work at below consequence:
  - Oval zone: "Central-Oval-Central-Oval-Central zone..."
  - Dual zone: "Central-Dual-Central-Dual-Central zone..."
2. When Oval Zone or Dual Zone active, the LED indicator of it will show heat setting and  alternately.

## Child Lock Safety Control

- You can lock the controls to prevent unintended use (for example children accidentally turning the cooking zones on) by active Child Lock function.
- When the controls are locked, except the ON/OFF control button and Child Lock control button, all other touch control buttons are disabled.



**To lock the controls**

Touch the Child Lock control button  once . The timer indicator will show "Lo", and Child Lock function be active.

## To unlock the controls

1. Make sure the electric cooktop is turned on.
2. Touch and hold the Child Lock control button  for 3 seconds, the buzzer beeps once and "Lo" disappears in timer indicator, the Child Lock be inactive.
3. You can now start using your electric cooktop.



Under the child lock mode, all controls button be disable except the ON/OFF button  and child lock  button.

You can always turn the cooktop off with the ON/OFF  control in an emergency, but you shall unlock the cooktop first in the next operation

**Note:** Under Child Lock function, if turn the cooktop off without inactive the Child Lock function. When turn on the cooktop later, the Child Lock function will still valid.

## Stop & Go function

- **Make cooking easy!** When cooking, your doorbell rings, phone rings, or kid shouts from another door. Need to step out of kitchen? These means dinner could burn, or take longer time to ready if you switch everything off.
- The **Stop & Go function** can turn off all zones. When you back, with one more touching of the button , cooktop restarts where they were, to carry on cooking.

### 1. Active Stop & Go function

To active **Stop & Go** function, you can press the **Stop & Go** function button once. Then all programmer setting be hold on and cooktop stop heating, all heat setting indicators show "P".

### 2. Inactive Stop & Go function

To cancel **Stop & Go** function, you can press the **Stop & Go** function again, after come back. Then all programmer setting will return to what they were, Stop & Go indicator "P" disappear from all indicators.



When **Stop & Go** function active, all control buttons are disable except the ON/OFF and Stop & Go button.

**Note:** The cooktop will auto turn off, if Stop & Go function last more than 10 minutes.

## Using the Timer

When the cooktop is turned on, you can use the timer in two different ways:

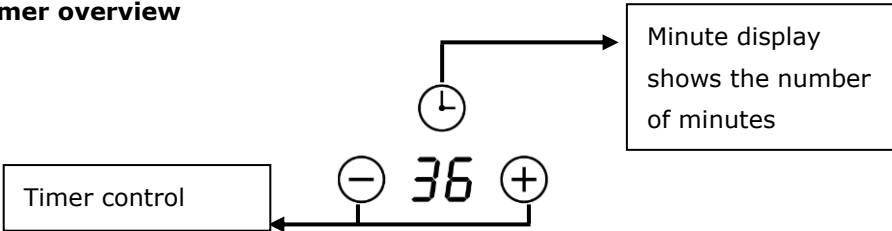

- You can use it as a minute minder. In this case, the timer will not turn any cooking zone off when the set time is up.
- You can set it to turn either or more than one cooking zones off.
- You can set the minute minder/timer for up to 99 minutes.

### Timer overview



## Using the Timer as a Minute Minder

### If you have not selected any cooking zones

1. Touch the timer control button , the number in timer indicator flashing.
2. Then adjust Minute Minder setting follows below:
  - Set heat setting by touching the  or  button.
  - If press and hold either of the two buttons, the value will adjust down or up rapidly in circle.

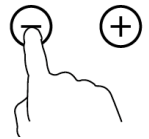

**Note:** When the timer indicator flashing, touch timer control button another time, can quick confirm the timer setting.

**Note:** By continuous touch the timer control button, it works at below consequence: "Single Digit-Tens Digit -Confirm Setting-Single Digit-..."

3. When the minute minder is set, it will begin to count down immediately, the display will show the remaining time.
4. Buzzer will beep for 30 seconds and timer indicator shows "--" when the setting time finished. Any efficient touching of control buttons during it, would end up the buzzer beeps.

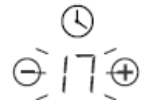

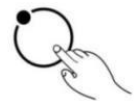

## Setting the timer to turn cooking zone off

1. Touch the heating zone selection control button to select the cooking zone you wish to set timer for.
2. Touch the timer control button , the number in timer indicator flashing.



### 3. Then adjust Timer setting

- Set heat setting by touching the  or  button.
- If press and hold either of the two buttons, the value will adjust down or up rapidly in circle.

**Note:** When the timer indicator flashing, touch timer control button another time, can quick confirm the timer setting.

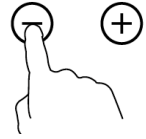

### 4. When the timer is set, it will begin to count down immediately, the display will show the remaining time.

**NOTE:** The red dot next to power level indicator will illuminate for those zones be set with timer. You can check timer setting of different cooking zone which set with timer, by active this cooking zone.

**NOTE:** If more than one heating zone has timer setting, the timer indicator will show the lowest time. The red dot next to power level indicator will flash.

### 5. When cooking timer expires, the corresponding cooking zone will be switch off automatically.

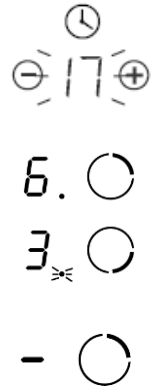

**Note:** The default setting of minute reminder and timer is 30 minutes.

**Note:** After adjusting, the setting in timer indicator will flashing for 5 seconds and then stop flashing, then the setting be confirmed.

**Note:** The minute reminder and timer can be use at same time, timer indicator shows the lowest time setting. If the lowest setting is minute reminder, the red dot next to timer indicator will flash. If the lowest setting is timer setting, the red dot of corresponding cooking zone power level indicator will flash.

**Note:** If indicator shows timer setting of cooking zone. To check minute reminder setting, press the timer control button , the indicator will show minute reminder setting.

## Residual Heat Warning

### Beware of hot surfaces

When the cooktop has been operating for some time, there will be some residual heat. The letter "H" appears in power setting indicator to warn you to keep away from it.

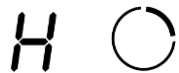

**It can also be used as an energy saving function:**

if you want to heat further pans, use the hotplate that is still hot.

## Auto Shutdown

Another safety feature of the cooktop is auto shutdown. This occurs whenever you forget to switch off a cooking zone. The default shutdown times as below table:

Power level	1	2	3	4	5	6	7	8	9
Default working timer (hour)	8	8	8	4	4	4	2	2	2

## Over-heat Protection

A temperature sensor equipped can monitor the temperature inside the cooktop. When an excessive temperature is monitored, the cooktop will auto stop operation.

## Over-flow Protection

For your safety, the programmer will auto shut off the power if liquid boiling or wet cloth over touch control panel. All control buttons became invalid except ON/OFF and Child Lock button, unless you wipe the touch control area dry.

## Cooking Guidelines

Take care when frying as the oil and fat heat up quickly, particularly if you are using Booster function. At extremely high temperature oil and fat will ignite spontaneously and this presents a risk of fire.

### Cooking Tips

- When food comes to the boil, reduce the power setting.
- Using a lid will reduce cooking times and save energy by retaining the heat.
- Minimize the amount of liquid or fat to reduce cooking times.
- Start cooking on a high setting and reduce the setting when the food has heated through.

### Simmering, cooking rice

- Simmering occurs below boiling point, at around 85°C, when bubbles are just rising occasionally to the surface of the cooking liquid. It is the key to delicious soups and tender stews because flavors develop without overcooking the food. You should also cook egg-based and flour thickened sauces below boiling point.
- Some tasks, including cooking rice by the absorption method, may require a setting higher than the lowest setting to ensure the food is cooked properly in the time recommended.



## Searing steak

To cook juicy flavorsome steaks:

1. Stand the meat at room temperature for about 20 minutes before cooking.
2. Heat up a heavy-based frying pan.
3. Brush both sides of the steak with oil. Drizzle a small amount of oil into the hot pan and then lower the meat onto the hot pan.
4. Turn the steak only once during cooking. The exact cooking time will depend on the thickness of the steak and how cooked you want it. Times may vary from about 2 – 8 minutes per side. Press the steak to gauge how cooked it is – the firmer it feels the more 'well done' it will be.
5. Leave the steak to rest on a warm plate for a few minutes to allow it to relax and become tender before serving.

## For stir-frying

1. Choose a ceramic compatible flat-based wok or a large frying pan.
2. Have all the ingredients and equipment ready. Stir-frying should be quick. If cooking large quantities, cook the food in several smaller batches.
3. Preheat the pan briefly and add two tablespoons of oil.
4. Cook any meat first, put it aside and keep warm.
5. Stir-fry the vegetables. When they are hot but still crisp, turn the cooking zone to a lower setting, return the meat to the pan and add your sauce.
6. Stir the ingredients gently to make sure they are heated through.
7. Serve immediately.

## Heat Settings

The settings below are guidelines only. The exact setting will depend on factors including your cookware and the amount you are cooking. Experiment with the cooktop to find the settings that best suit you.

Heat setting	Suitability
1 - 2	<ul style="list-style-type: none"><li>• delicate warming for small amounts of food</li><li>• melting chocolate, butter, and foods that burn quickly</li><li>• gentle simmering</li><li>• slow warming</li></ul>
3 - 4	<ul style="list-style-type: none"><li>• reheating</li><li>• rapid simmering</li><li>• cooking rice</li></ul>
5 - 6	<ul style="list-style-type: none"><li>• pancakes</li></ul>
7 - 8	<ul style="list-style-type: none"><li>• sautéing</li><li>• cooking pasta</li></ul>

9	<ul style="list-style-type: none"><li>• stir-frying</li><li>• searing</li><li>• bringing soup to the boil</li><li>• boiling water</li></ul>
---	---

## Part 4. Cleaning and Maintenance

### Cleaning and Maintenance

**Important: Before any maintenance or cleaning work is carried out, DISCONNECT the appliance from ELECTRICITY supply and ensure the appliances is completely cool.**

#### Cleaning the Cooktop Surface

Clean spillages from the cooktop surface as soon as possible after use. Always ensure the surface is cool enough before cleaning.

Use a soft cloth or kitchen paper to clean the surface. If the spillage has dried on the surface, you may need to use a specialist vitro-ceramic glass cleaner, which is available for most of supermarkets.

Do not use other abrasive cleaners and/or wire wool etc., as it may scratch the ceramic glass surface of your cooktop.

#### Damage from Sugary Spills and Melted Plastic

Special care should be taken when removing hot substances **to avoid permanent damage of the glass surface.**

Sugary spillovers (such as jellies, fudge, candy, syrups) or melted plastics can cause pitting of the surface of your cooktop (**not covered by the warranty**) unless the spill is removed while still hot. Special care should be taken when removing hot substances.

## Hints and Tips

What?	How?	Important!
<p>Everyday soiling on glass (fingerprints, marks, stains left by food or non-sugary spillovers on the glass)</p>	<ol style="list-style-type: none"> <li>1. Switch off the power supply.</li> <li>2. Apply a vitro-ceramic glass cleaner while the glass is still warm (but not hot!)</li> <li>3. Rinse and wipe dry with a clean cloth or paper towel.</li> <li>4. Switch on the power supply to the cooktop.</li> </ol>	<ul style="list-style-type: none"> <li>• When turn off the power supply of cooktop, there will be no 'hot surface' indication but the cooking zone may still be hot! Take extreme care.</li> <li>• Heavy-duty scourers, some nylon scourers and harsh/abrasive cleaning agents may scratch the glass. Always read the label to check if your cleaner or scourer is suitable.</li> <li>• Never leave cleaning residue on the cooktop glass surface: the glass may become stained.</li> </ul>
<p>Boil over, melts, and hot sugary spills on the glass</p>	<p>Remove these immediately with a fish slice, palette knife or razor blade scraper suitable for ceramic glass of cooktop, but beware of hot cooking zone surfaces:</p> <ol style="list-style-type: none"> <li>1. Switch off the power supply.</li> <li>2. Hold the blade or utensil at a 30° angle and scrape the soiling or spill to a cool area of the cooktop.</li> <li>3. Clean the soiling or spill up with a dish cloth or paper towel.</li> <li>4. Follow steps 2 to 4 for 'Everyday soiling on glass' above.</li> </ol>	<ul style="list-style-type: none"> <li>• Remove stains left by melts and sugary food or spillovers as soon as possible. If left to cool on the glass, they may be difficult to remove or even permanently damage the glass surface.</li> <li>• Cut hazard: when the safety cover is retracted, the blade in a scraper is razor-sharp. Use with extreme care and always store safely and out of reach of children.</li> </ul>
<p>Spillovers on the touch controls</p>	<ol style="list-style-type: none"> <li>1. Switch off the power supply.</li> <li>2. Soak up the spill</li> <li>3. Wipe the touch control area with a clean damp sponge or cloth.</li> <li>4. Wipe the area completely dry with a paper towel.</li> <li>5. Switch on the power supply to the cooktop.</li> </ol>	<ul style="list-style-type: none"> <li>• The cooktop may beep and turn itself off, and the touch controls may not function while there is liquid on them. Make sure you wipe the touch control area dry before turning the cooktop back on.</li> </ul>

## **Maintenance of the Cooktop**

**If you find something goes wrong for your cooktop, before contact the service or where you purchased it, please check whether below:**

1. There is no power to the appliance:

- Check whether there is a power cut of your department;
- Check whether the appliance be connected to electricity properly;
- Has the timer setting elapsed;
- Whether it reaches the longest cooking time setting and auto shut off;
- Whether there is liquid boiling over touch control panel and overflow protection devices auto shut off;

2. The touch control panel buttons can't be active:

- Whether it's under "Child Lock", which there is "Lo" shows in timer displayer;
- Whether liquid/wet cloth over touch control panel active overflow protection;

3. After cooking there is "H" shows on display:

- This is normal. The cooktop is with Residual Heat Warning safety features. It will remain on until the surface is cool enough for touch.

4. After turn off, the fan of induction cooktop remains working for a while:

- This is normal, this is to help appliances completely cool down.

5. Some pans make crackling or clicking noises during use of induction cooktop:

- This is normal, it's the sound of induction coils during working, and for different construction of your cookware, the clicking might be slightly different.

6. The glass is being scratched:

- Check whether you use unsuitable cookware, like rough-edged cookware.
- Check whether unsuitable, abrasive scourer or cleaning products being used.

7. The heating element of ceramic cooktop turns on and off alternately when working:

- This is normal and natural feature for ceramic cooktop. Programmer of ceramic cooktop, together with the thermostat or thermocouple in heating element, could control the cooktop work at set power level and avoid overheat by heating element work on/off alternately.

-If working at highest power level, heating element will continue turn on for a certain time then on/off alternately.

-If working at other lower power level, heating element will on/off alternately at certain frequency since beginning based on power setting of the cooking zone.



**WARNING:** This product can expose you to chemicals including Nickel (Metallic) which is known to the State of California to cause cancer.

For more information go to [www.P65Warnings.ca.gov](http://www.P65Warnings.ca.gov)

Note: Nickel is a component in all stainless steel and some other metallic compositions.