

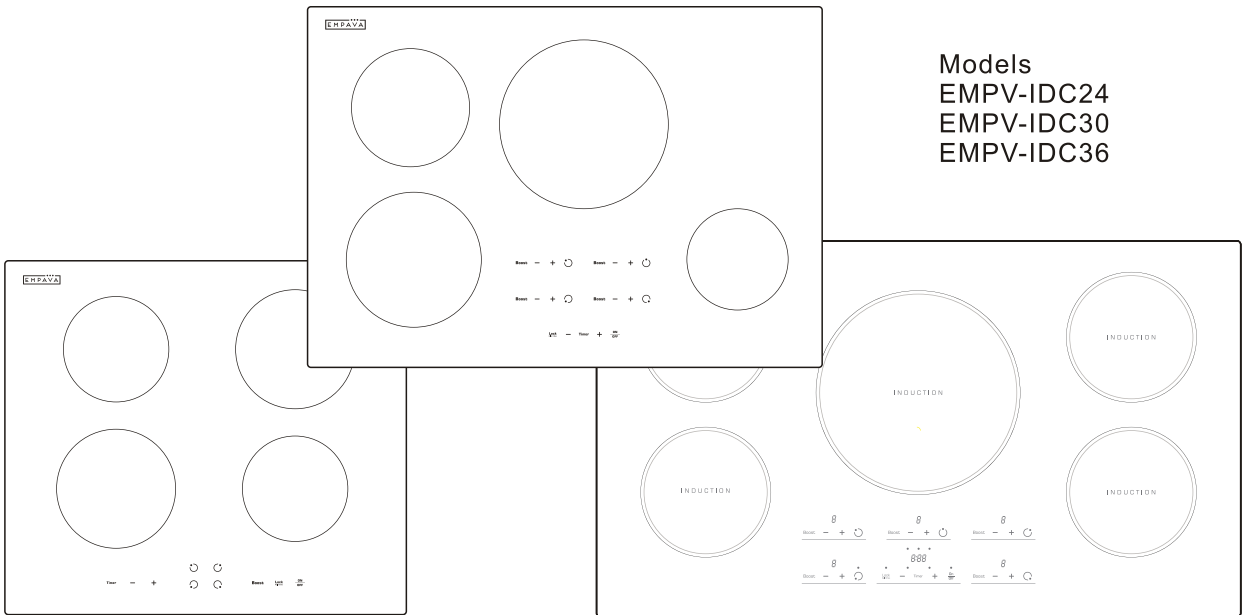

USE AND CARE GUIDE Induction Cooktop



Models
EMPV-IDC24
EMPV-IDC30
EMPV-IDC36

Distributed by Empava Appliances Inc.
Add: 15253 Don Julian Road, City of Industry, CA, 91745
Tel: (888)682-8882
WWW.EMPAVA.COM



TABLE OF CONTENTS

Important Safety Instructions.....	1-4
Cooktop Features.....	5-10
Using The Cooktop.....	11-14
Operational Cooktop Noises.....	15
Compatible Cookware.....	16
Cleaning Your Cooktop.....	17
Troubleshooting Guide.....	18-19
Installation Instructions.....	20-27

About Induction Cooking

Induction cooking is a safe, advanced, efficient, and economical cooking technology. It works by electromagnetic field generating instant heat directly in the cookware bottom, rather than indirectly through heating the glass surface. The glass becomes hot only because the cookware warms it up.

Our induction cooktop has been tested and complies with Part 18 of the FCC Rules for ISM equipment. Product meets the FCC requirements to minimize interference with other devices in residential installation.

Important Safety Instructions

IMPORTANT Keep these instructions handy for future use.

The appliance is manufactured in compliance with the relevant safety standard.

⚠ WARNING Read all instructions carefully before installation and operation of the appliance.

⚠ WARNING Failure to follow these warnings could result in a fire or explosion that causes property damage, personal injury or death. To reduce the risk of fire, electric shock or injury, take the following precautions:

Intended Use

- This appliance is designed for built-in household use only.
- Do not use outdoors.
- Do not use the appliance to heat a room.

⚠ WARNING **Cooking Safety**

- Do not allow aluminum foil, paper or cloth to come in contact with a hot element.
- Avoid preparing food in aluminum foil or plastic containers over the hot cooking zones.
- Protective liners - Do not use aluminum foil to line cooking zone, drip bowls or oven bottoms, except as suggested in the manual. Improper use of these liners may result in a risk of electric shock or fire.
- Do not allow pans to boil dry or empty.
- Never leave the cooktop unattended when in use.
- Always use the proper pot and pan size.
- The use of undersized cookware will expose a portion of the hot element, which can result in ignition of clothing or personal burners.



- Always remove the covers on sealed or canned goods and before heating to avoid explosion.
- Close supervision is necessary when any appliance is used by or near children.
- Do not touch hot surfaces. Use dry pot holders to hold the handles of pots and pans.
- Use only dry potholders - moist or damp potholders on hot surfaces may result in burns from steam. Do not let the potholder touch hot heating elements.
- Do not use a towel or other bulky cloth.
- Nevertheless, we strongly recommend that a person with physical or mental impairments not use the appliance unless accompanied by a qualified person. The same recommendation applies to children.
- When the unit is on, do not touch outside the control panel as the surface may contain residual heat. It is important to be aware that the unit's surface will remain hot for a short period of time after use. Do not touch hot surfaces.

Important Safety Instructions



WARNING Cleaning Safety

- Do not use steam cleaners or high-pressure cleaners to clean the cooktop, as this may result in electric shock.

Condition of Unit

-  **WARNING** Do not operate any appliance with a damaged cord or after the appliance malfunctions or has been damaged in any manner. Return appliance to the nearest authorized service facility for examination, repair, or adjustment.
-  **IMPORTANT Do Not Cook on Broken Cooktop.** If cooktop break, cleaning solutions and spillovers may penetrate the broken cooktop and create a risk of electric shock.

IMPORTANT Environment of Unit

- To reduce the risk of fire, do not let any objects(glass, paper, etc.) obstruct the inlet and outlet of your cooktop.
- To reduce the risk of electric shock, do not mount unit over a sink.
- To reduce the risk of fire, do not store anything directly on top of the appliance surface when the appliance is in operation.
- Always have a working smoke detector in or near the kitchen.
-  **CAUTION** Do not leave lids or other metal objects such as knives, forks or spoons on the cooktop. If the cooktop is turned on, these objects can heat up quickly and may cause burns. Do not place rough or uneven objects on the units as they may damage the surface. If the cooktop is near a window, ensure that curtains do not blow over or near the unit.
-  **IMPORTANT** Do not use the cooktop as a work surface. Certain substances such as salt, sugar, or sand can scratch the glass ceramic surface. Do not store hard or pointed objects over the cooktop as they can damage the unit if they fall on top.

Important Safety Instructions

Environment of Unit

- Do not put detergents or flammable materials in the equipment installed under the cooktop.
- While cooking any overflowed fat or oil on the cooktop may ignite. There is a risk of burning and fire; therefore, control the cooking process at all times.
- The use of accessory attachments not recommended by the appliance manufacturer may cause injuries. Items with a magnetic field such as: radios, televisions, credit cards, cassette tapes etc., can affect the unit.
- The marked electrical rating should be at least as great as the electrical rating on the appliance.
- To prevent accidents and achieve optimal ventilation, allow for sufficient space around the cooking area.

- **⚠CAUTION** Do not store items of interest to children in cabinets above the range or on the backguard of a range - children climbing on the range to reach items could get seriously injured.
- Use proper cookware size - This appliance is equipped with four Cooking Elements of different sizes.
- Choose cookware with a flat bottom large enough to cover the unit heating surface. The use of undersized cookware will expose a portion of the heating surface where direct contact may be made and cause serious injury. Compatible cookware will improve efficiency.

- To reduce risk of burns, ignition of flammable materials, and spillage due to unintentional contact with cookware, the cookware handles should be turned inward and not extend over adjacent heating surface.
- Wear proper apparel - loose fitting or hanging garments should never be worn while using the appliance.

⚠WARNING Power Cord Safety

- **⚠WARNING** To protect against electric shock, do not immerse cord, or main body in water or any other liquid.
- Do not let cord hang over edge of table or counter.
- Do not allow cord to touch hot surface. A short power supply cord or detachable power supply cord should be used to reduce the risk of becoming entangled in or tripping over a longer cord.
- Always attach plug to appliance first, then plug cord into the wall outlet. To disconnect, turn any control to off, then remove plug from wall outlet.
- The cord should be arranged so that it will not drape over the countertop where it can be pulled on by children or tripped over.

Service and Repair Safety

- **⚠️ WARNING** Do not repair or replace any part of the appliance unless specifically recommended in the manual. All other services should be referred to a qualified technician.

This product may not be treated as household waste. Instead it should be handed over to the applicable collection point for the recycling of electrical and electronic equipment. By ensuring this product is disposed of correctly, you will help prevent potential negative consequences for the environment and human health, which could otherwise be caused by inappropriate waste handling of this product. For more detailed information about recycling of this product, please contact your local city office, your household waste disposal service or the shop where you purchased the product.

SAVE THESE INSTRUCTIONS

Cooktop Features

24" Model EMPV-IDC24

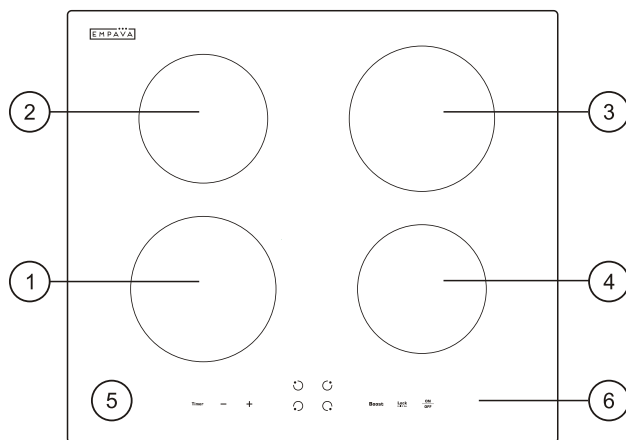

1. Front left cooking element control area
2. Rear left cooking element control area
3. Rear right cooking element control area
4. Front right cooking element control area
5. Ceramic glass
6. Touch control panel

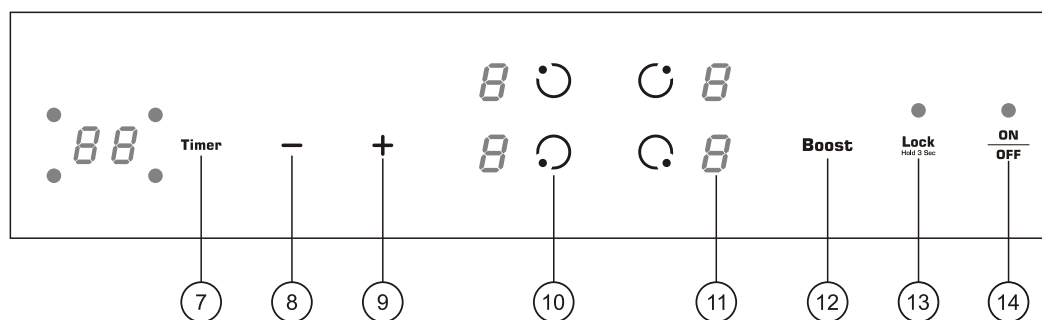

7. Minuter timer
8. Decrease power or time
9. Increase power or time
10. Cooking element symbol and Power ON
11. Power level and residual heat display
12. Power boost
13. Controls Lock
14. Main Power on/off

30" Model EMPV-IDC30

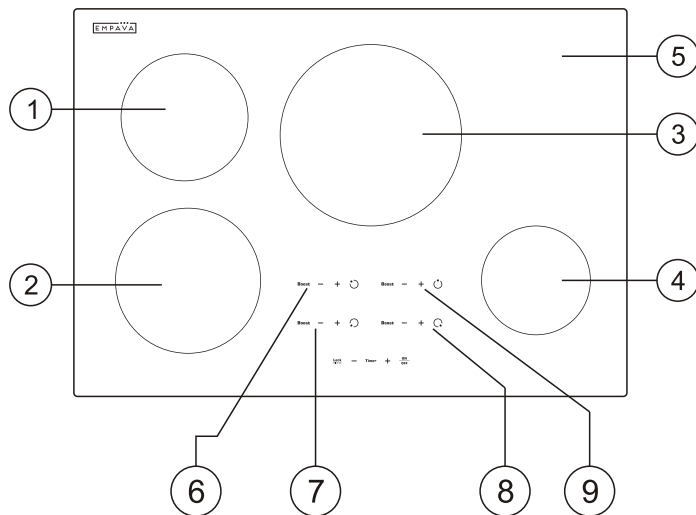

1. Left rear cooking element
2. Left front cooking element
3. Right rear cooking element
4. Right front cooking element
5. Ceramic glass
6. Left rear cooking element control area
7. Left front cooking element control area
8. Right front cooking element control area
9. Right rear cooking element control area

Cooktop Features

30" Model EMPV-IDC30

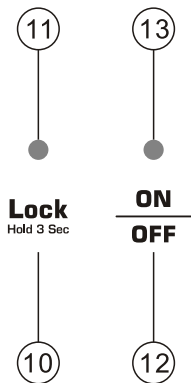

- 10. Controls Lock
- 11. Controls Lock indicator light
- 12. Main Power On/Off
- 13. Main Power indicator light

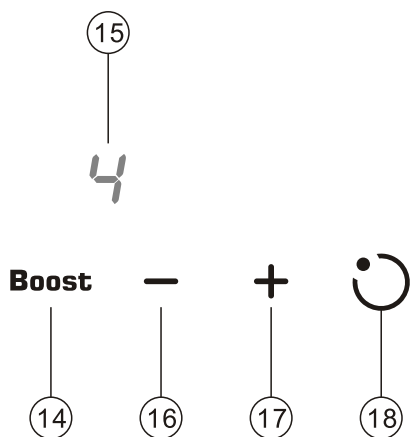

- 14. Power Boost
- 15. Power level and Residual heat display
- 16. Decrease power
- 17. Increase power
- 18. Cooking element symbol and Power On/Off

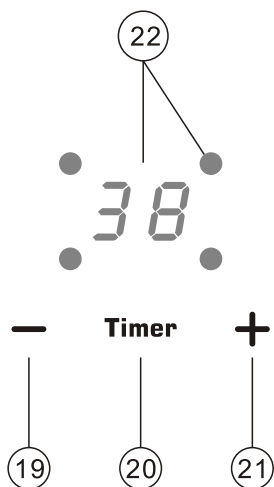

- 19. Minute timer setting Down
- 20. Minute timer
- 21. Minute timer setting Up
- 22. Minute timer display window and cooking element symbol

36" Model EMPV-IDC36

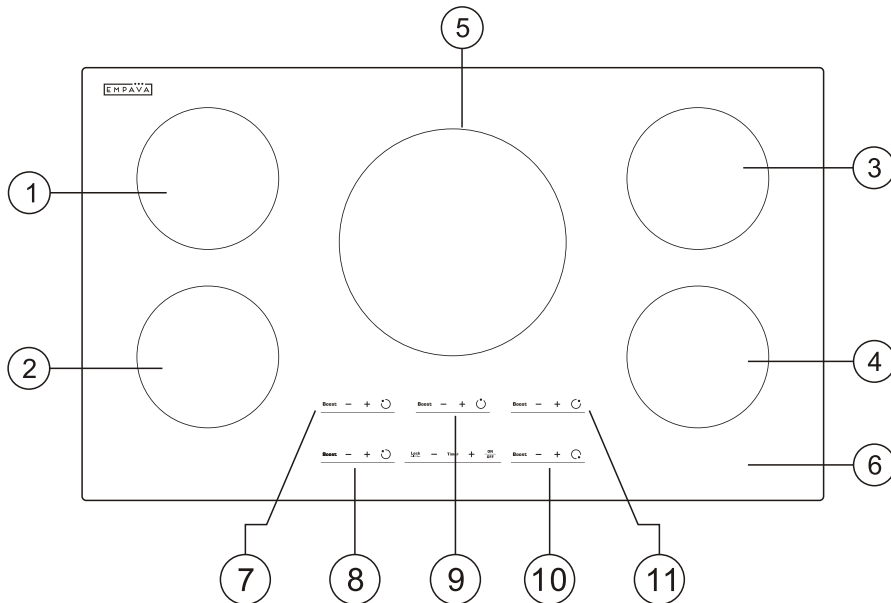

1. Left rear cooking element
2. Left front cooking element
3. Right rear cooking element
4. Right front cooking element
5. Center cooking element
6. Ceramic glass
7. Left rear cooking element control area
8. Left front cooking element control area
9. Center cooking element control area
10. Right front cooking element control area
11. Right rear cooking element control area

Cooktop Features

36" Model EMPV-IDC36

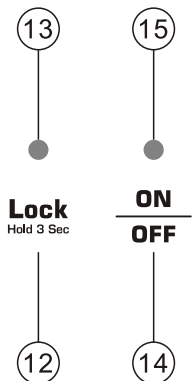

- 12. Controls Lock
- 13. Control Lock indicator light
- 14. Main Power On/Off
- 15. Main Power indicator light

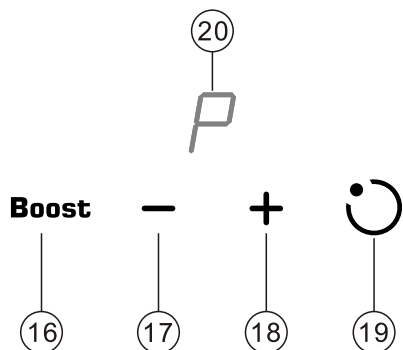

- 16. Power Boost
- 17. Decrease power
- 18. Increase power
- 19. Power On/Off
- 20. Power level and Residual heat display

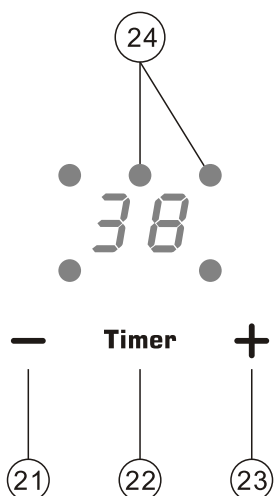

- 21. Minute timer setting Down
- 22. Minute timer
- 23. Minute timer setting Up
- 24. Minute timer display window and cooking element symbol

Cooktop Features

Specifications

Model	EMPV-IDC24	EMPV-IDC30	EMPV-IDC36
Product dimension(wxdxh) inch	23 ⁷ / ₃₂ " x 20 ¹⁵ / ₃₂ " x 2 ¹ / ₈ "	30" x 21" x 2 ¹ / ₈ "	36" x 21" x 2 ¹ / ₈ "
Cut-out dimension(wxd) inch	Min.:22 ¹ / ₂ " x 18 ⁵ / ₁₆ " Max.:22 ⁷ / ₈ " x 20 ¹ / ₁₆ "	Min.:29 ⁹ / ₁₆ " x 19 ⁷ / ₈ " Max.:29 ¹ / ₁₆ " x 20 ¹ / ₁₆ "	Min.:35 ⁷ / ₃₂ " x 19 ⁷ / ₈ " Max.:35 ⁷ / ₁₆ " x 20 ¹ / ₁₆ "
Voltage (volts)	240	240	240
Frequency (Hz)	60	60	60
Total power (Watts)	7400	7400	9600
Minimum circuit breaker Amperage	40	40	50
Elements	4	4	5
Front Left	2100W/2700W	2100W/2500W	1600W/2000W
Rear Left	1600W/2000W	1600W/2000W	1600W/2000W
Front Right	1600W/2000W	1400W/1800W	1800W/2400W
Rear Right	2100W/2700W	2300W/2700W	1800W/2400W
Center	N/A	N/A	2400W/3700W

Heat Setting Displays

DISPLAY	DESCRIPTION
-	No power level for the element
L	The keep warm function
1-9	The power level
P	The power boost
H	A cooking element is still hot to touch (residual heat)
E	Electronics fault error message of specific cooking element
E0-E9	Error code

Using The Cooktop

This manual covers different models. The cooktop you have purchased may have some or all of the features listed.

Controls Lock

- Controls Lock is activated when the cooktop is off: Controls Lock prevents activation of any sensor key, except for the Lock key pad, so you must deactivate the control lock firstly, then touch the main POWER key pad to turn on the cooktop.

- Controls Lock is activated during the cooktop use: Controls Lock prevents activation of any sensor key, except for the ON/OFF, Power and Lock key pad.

To Lock

Touch and Hold Lock key pad for 3 seconds, a “beep” will sound and the indicator light above the Lock key pad will be lit up.

To unlock

Touch and Hold Lock key pad for 3 seconds, a beep will sound, the indicator light will turn OFF.



! IMPORTANT

Touch and hold for 3 seconds

To Turn On The Cooktop

While in the **Standby mode**, touch the Main “Power” key pad, a “beep” will sound and the indicator light above the Power key pad will be lit up, indicating that the induction cooktop functions are ready to use. The unit will automatically

return to **Standby mode** if no ON/OFF keys are touched within 30 seconds.

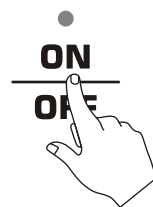

Operating The Cooking Elements

To turn on one or more Cooking Elements, place a compatible pot or pan on the desired cooking element. With the cooktop being ON as mentioned above, touch the “ON” key pad of the desired cooking element, the Power display will show a “-”, indicating no power level for the Element has been set yet, then press either the “+” key, “-” key or “Boost” (Power Boost) key to select a cooking level. The selected cooking element will automatically turn off if no power selection key is not pressed within 30 seconds.

Touch the Minus key (-) to start at low level, the power display will show 1.



Touch the Plus key (+) to start at high level, the power display will show 9.



Touch the “Boost” key, it will show on the display as a “P” and Power Boost LED is lit up, boosting the heating power to the highest level for 10 minutes.



Power Management

Touch “-” key or “+” key to adjust the desired power level;

NOTE: During cooking, the unit is equipped with safeguards against parching.

NOTE: Heating will appear intermittent phenomenon when cooking element is used for frying, stir-frying, grilling and other high temperature cooking formats.

Automatic Power Level Control

The power level displayed may be different from the actual power level at the power sharing and high temperature range. To prevent the cooktop from overheating, the power level is controlled automatically.

Power Boost

Touch “+” key to level 9, then press once to enter into Boost mode, the power display will show a “P”. The 'Boost' function is used to cook at maximum power for a short period of time (maximum 10 minutes). The power is reduced to level 9 at the end of the maximum boost time.

In the Boost status, touch “-” key or after 10 minutes the power boost setting will switch off automatically, Power digital will switch from P to 9.

! WARNING Power Boost is only recommended for BOILING WATER.

! WARNING Do not leave a pot unattended while in **Boost Mode** or other high power settings.

Keep Warm

While in the Power level 1, touch “-” key to enter into Keep Warm mode, Power digital will switch from 1 to L.

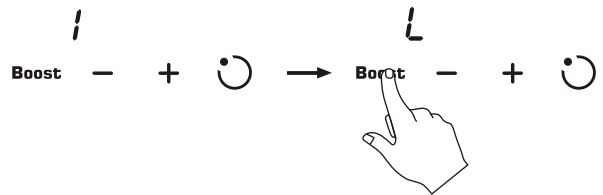

Using The Cooktop

Power Sharing

Four or five cooktops are divided into two separate cooking area, the right and left side cooking elements share power of a inverter.

Power sharing is activated when the cooking element in the same area are activated; the controls adjust the power automatically for "Power Sharing". This power sharing is administered by unit's microprocessors, which will alternate power in one area.

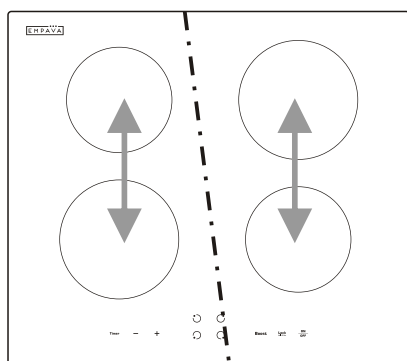

Left Zone Right Zone
24" (59cm) Model EMPV-IDC24

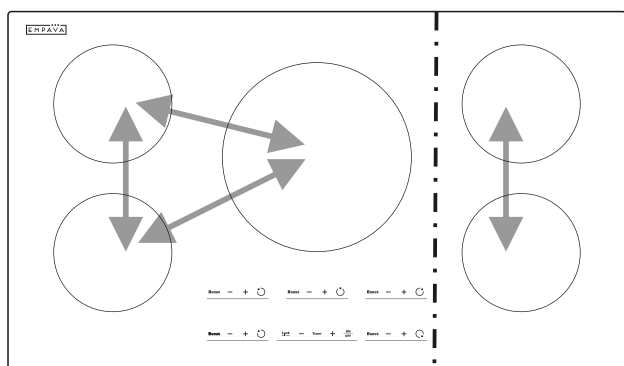

Left Zone Right Zone
36" (91.4cm) Model EMPV-IDC36

Power sharing tips: Remember to select the power setting last for the cooking element you want to maintain at full setting heat. To maintain full setting heat for two items, place one item on a element in one section (left side), and the other item on a element in another section (right side).

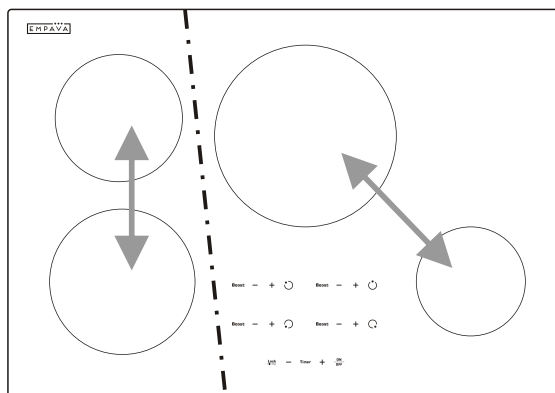

Left Zone Right Zone
30" (76.2cm) Model EMPV-IDC30

Residual Heat Indicator



After using any of the Cooking Element, the cooking area will remain hot. Even after turning off the entire unit, the surface of the cooktop will remain hot for some time. The digital display for the Cooking Element will show an "H" to warn the user that the surface is hot to touch (Hot surface indicator) after the Cooking Element switch off. Wait until the "H" is no longer displayed to clean the unit. You may turn the Cooking Element back on even if the "H" is displayed.

Set Timer

Use “+” or “-” key to adjust and set the desired time. A short key press adjusts the time by 1 minute and a long key press by 10 minutes. The automatic timer settings range from 1 minute to 99 minutes. (**NOTE:** There is no “seconds” and “hours” display, only minutes.) The red dot next to the Time symbol indicator will illuminate indicating that the cooking elements is selected.

While cooking, touch the Timer key pad until time light of the desired cooking element is ON, Time digital display reads “00” and blinking; Touch “+” or “-” key to set the desired number, Once the Timer is set and no “+” or “-” key are pressed for 5 seconds, the Minute Timer begins the countdown and the timer display will stop blinking and will stay on in the display. Once the Minute Timer reaches “00”, a “beep” will be sound, indicating that the time is up, the Particular Cooking Element will automatically shut off.

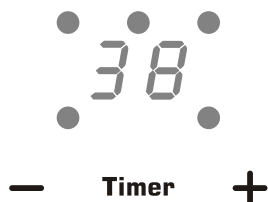

If you want to set another burner to switch-off automatically, touch Timer key to until the desired time symbol indicator blinks, repeat the same steps above.

If you want to check the remaining time for another Cooking Element, touch the Timer until the Time symbol indicator for the desired Cooking Element blinks.

If more than one switch-off time is programmed, the shortest time remaining will show in the Time digital display, the indicator for that particular burner will be blinking.

To Cancel Timer

Touch the Timer until the Time symbol indicator for the desired Cooking Element blinks, then touch the “+” or “-” to set the timer to 00. The Time digital display will blink for 5 seconds and then turn off, indicating that the timer of selected cooking element has been cancelled.

Operational Cooktop Noises

Cookware Noise

The induction fields are generated by electronics equipment, which are pretty much silent but they do produce heat at high power level. A soft-sounding cooling fan runs when the unit is running multiple cooking elements at high settings at once or when a cooking element is set at very high power settings.

What can sometimes produce sound with induction cooking is not the induction equipment but the cookware itself. Slight sounds may be produced by different types of cookware. Some of the possible causes include:

- Heavier pans such as enameled cast iron produce less noise than a lighter weight multi-ply stainless steel pan; Light weight cookware may also vibrate. Heavy weight quality cookware is recommended.
- Cookware with irregular or warped bottoms can vibrate audibly on the ceramic glass surface, though again typically only at high power settings.
- A “Cracking” noise may be heard if the cookware base is made of layer of different material.
- A low “humming” noise occurs when cooking, which is normal particularly at high power settings.
- Whistling can occur if both elements are being used at the same time at the high settings, and the cookware has bases made of layer of different material.
- Loose-fitting handles on cookware, typically when riveted on, can vibrate slightly.
- High quality cookware of solid cast iron including enamelware will lower the noise.

Compatible Cookware

The quality of your cooking is dependent on the cookware you use. Because induction cooking requires a magnetic vessel for heating, only certain materials can be used on your cooktop.

Induction requires pots and pans that are made of ferrous (meaning magnetic) materials.

Check your cookware's retail box for the induction symbol. To tell if your current cookware is compatible with the induction technology, grab a magnet and see if it holds to the bottom of the cookware. If your magnet stays on then your cookware is ready to be used on the Induction cooktop!

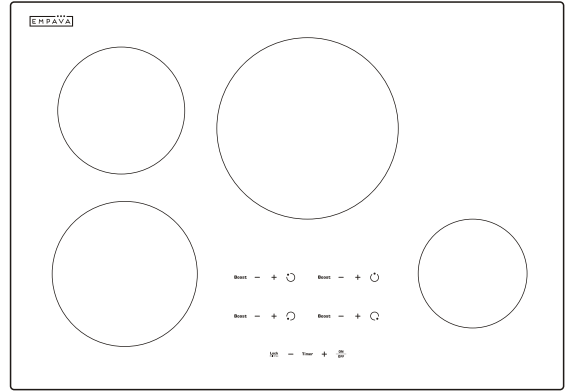

Optimally the cookware will have this induction image on the retail box:

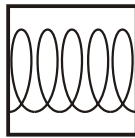

Induction

The following are **not** compatible: heat-resist glass, ceramic, copper, aluminum pan/pots, round-bottomed cookware, or cookware with a base less than 5 inches.

NOTE: Some cookwares can produce noises when used on induction cooking zones. This is not a fault in the cooktop, and its function will not be impaired in any way as a result.

Cleaning Your Cooktop

Please follow these directions along with Important Safety steps for cleaning, advised at the beginning of the manual. Use a ceramic glass cleaner on the glass cooktop. To maintain and protect the surface of your glass cooktop, follow these steps:

Before using the cooktop for the first time, clean it to protect the top and makes cleanup easier.

1. Daily use of ceramic glass cleaner when the cooktop is cool will keep the cooktop looking new.
2. Shake the cleaning solution well. Apply a few drops of ceramic glass cleaner directly to the cooktop.
3. Use a paper towel or a soft cleaning pad for ceramic surface to clean the entire cooktop surface.
4. Use a dry cloth or paper towel to remove all cleaning residue. No need to rinse. Never run the cooktop under water.

Cleaning Burned on Residue:

NOTE: It is very important that you **DO NOT** use the cooktop until it has been thoroughly cleaned.

WARNING: Damage to the glass surface may occur if you use scrub pads or any other type of abrasive cleaning materials.

1. Allow the cooktop to cool.
2. Spread a few drops of the ceramic glass cleaner on the burned residue area.
3. Using the ceramic glass cleaning pad, rub the residue area, applying pressure as needed.
4. If any residue remains, repeat the steps listed above.
5. For additional protection, after all residue has been removed, polish the entire surface with the ceramic glass cleaner and a paper towel.

Cleaning heavy burned - on residue:

1. Allow the cooktop to cool.
2. Used a singleedge razor blade scraper approximately at a 45 degree angle against the glass surface, and scrape offtheresidue.
3. After scraping off the residue, apply a few drops of the ceramic glass cleaner on the entire burned residue area. Use the cleaning pad to remove any remaining residue.
4. For additional protection, after all residue has been removed, polish the entire surface with the ceramic glass cleaner and a paper towel.

Metal Marks and Scratches:

Be careful not to slide pots or pans across the cooktop surface. It will leave behind metal markings. These marks are removable using the ceramic glass cleaner along with the cleaning pad for induction cooktop.

If pots with a thin overlay of aluminum or copper boil dry, the overlay may leave a black discoloration on the cooktop. This should be removed immediately before using the cooktop again or the discoloration will become permanent.

NOTE:If cracks or indentations in the glass surface occurs, the cooktop glass will have to be replaced. Contact the manufacturer for assistance.

Troubleshooting Guide

If you encounter the following problems while using your cooktop, check the guide below to see if you can correct the problem yourself before calling for assistance or service:

Problem	Possible Cause	Solutions
<ul style="list-style-type: none"> • Cooktop does not work 	<ul style="list-style-type: none"> • Cooktop controls are locked • Power outage • Installation wire not complete • Circuit breaker has tripped or fuse is blown 	<ul style="list-style-type: none"> • Make sure Lock mode is turned off • Check house lights to confirm power outage
<ul style="list-style-type: none"> • Cooktop does not heat 	<ul style="list-style-type: none"> • No cookware or improper cookware placement on the cooking element • Incorrect cookware size for the selected cooking element • Cookware is not properly resting on cooking element • Incorrect cooking element selected • No power to cooktop 	<ul style="list-style-type: none"> • Make sure that the cookware is centered on the cooking element, and that cookware is also of correct type for induction cooking. See Compatible Cookware • The bottom of the cookware must be large enough to cover cooking element completely. See Compatible Cookware • Cookware bottoms must be flat and centered on the cooking element. See Compatible Cookware • Make sure the correct control is ON for the cooking element being used • See “Cooktop does not work” above
<ul style="list-style-type: none"> • Cooktop turns off while cooking 	<ul style="list-style-type: none"> • Cooktop internal heat sensor has detected high temperature inside the cooktop, activating automatic shut off • Liquid or object on the controls area 	<ul style="list-style-type: none"> • Make sure the cooktop vents are not blocked • The cooktop features an automatic shutoff feature that turns off the entire cooktop if any cooking element has been on continuously for 2 hours • The cooktop control panel may register liquids or objects obstructing the panel, which can cause the cooktop to shut off. Clean up spills or remove objects and restart the unit

Troubleshooting Guide

If you encounter the following problems while using your cooktop, check the guide below to see if you can correct the problem yourself before calling for assistance or service:

Problem	Possible Cause	Solutions
<ul style="list-style-type: none"> • Power boost does not work 	<ul style="list-style-type: none"> • Boost function is not available if adjacent burner is in use and total power reach 3700W or 4800W (right zone or left zone) 	<ul style="list-style-type: none"> • See Power Sharing
<ul style="list-style-type: none"> • The fans keep running for one minute after the cooking element has been switched off 	<ul style="list-style-type: none"> • The electronics are cooling down 	<ul style="list-style-type: none"> • This is a normal occurrence
<ul style="list-style-type: none"> • “E” appears in the Power display 	<ul style="list-style-type: none"> • Electronics fault error message of particular cooking element 	<ul style="list-style-type: none"> • See E0, E1, E2, E3, E7, E8, E9, EE
<ul style="list-style-type: none"> • “E0” appears in the Timer display 	<ul style="list-style-type: none"> • IGBT overheating 	<ul style="list-style-type: none"> • Turn off unit to allow IGBT to cool. Restart unit
<ul style="list-style-type: none"> • “E1” appears in the Timer display 	<ul style="list-style-type: none"> • No cookware found or improper placement of cookware on the cooking element 	<ul style="list-style-type: none"> • Make sure that the cookware is centered on the cooking element, and that it is also induction compatible. See Compatible Cookware
<ul style="list-style-type: none"> • “E2” appears in the Timer display 	<ul style="list-style-type: none"> • Supplied voltage to cooktop is too low 	<ul style="list-style-type: none"> • This may be caused by reduced voltage being supplied to the house circuit. If connections are correct and the supplied voltage returns to normal, the code will disappear
<ul style="list-style-type: none"> • “E3” appears in the Timer display 	<ul style="list-style-type: none"> • Supplied voltage to cooktop is too high 	<ul style="list-style-type: none"> • This may be caused by increased voltage being supplied to the house circuit. If the connections are correct and the supplied voltage returns to normal, the code will disappear
<ul style="list-style-type: none"> • “E7” appears in the Timer display 	<ul style="list-style-type: none"> • NTC1 Break off 	<ul style="list-style-type: none"> • Turn the cooktop OFF; then pull plug out for about 30 seconds. Then re-insert the plug and turn the cooktop on using the POWER pad. If the error message is still displayed, call for service
<ul style="list-style-type: none"> • “E8” appears in the Timer display 	<ul style="list-style-type: none"> • NTC1 Short circuit 	
<ul style="list-style-type: none"> • “E9” appears in the Timer display 	<ul style="list-style-type: none"> • NTC2 Break off 	
<ul style="list-style-type: none"> • “EE” appears in the Timer display 	<ul style="list-style-type: none"> • NTC2 Short circuit 	
<ul style="list-style-type: none"> • Noise 	<ul style="list-style-type: none"> • Noise like humming, crackling and buzzing 	<ul style="list-style-type: none"> • This is a normal occurrence, See Operational Cooktop Noises

IMPORTANT SAFETY INFORMATION

⚠ WARNING Installation and service must be performed by a qualified installer or service technician.

IMPORTANT Read and save these instructions for future reference.

⚠ DANGER Always read and obey all safety information, failure to follow these instructions can be killed or seriously injured.

Before Installing the cooktop

1. Visually inspect the cooktop for damage. Also make sure all cooktop screws are on tight.
 2. Record the model and serial number as found on the bottom of your cooktop. When ordering parts for or making inquiries about your cooktop, always be sure to include the model and serial numbers and a lot number or letter from the serial plate on your cooktop.
 3. Cutout dimensions of the countertop.
 4. Make sure the wall coverings, countertop and cabinets around the cooktop can withstand heat (up to 200°F) generated by the cooktop.
 5. Gently lower the cooktop into the countertop cutout.
- NOTE:** Do not seal the cooktop to the countertop, the cooktop must be removable if service is necessary.

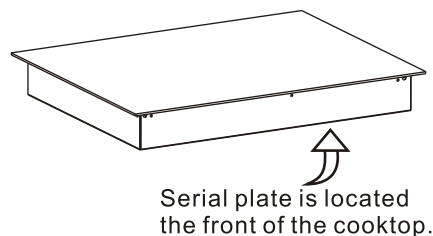

Electrical Connection

⚠ IMPORTANT Observe all governing codes and local ordinances.

Model EMPV-IDC24 needs 40 Amp service.

Model EMPV-IDC30 needs 40 Amp service.

Model EMPV-IDC36 needs 50 Amp service.

Maximum Connected Load

Model EMPV-IDC247.4 kW at 240 VAC, 6.4 kW at 208 VAC

Model EMPV-IDC307.4 kW at 240 VAC, 6.4 kW at 208 VAC

Model EMPV-IDC369.6 kW at 240 VAC, 8.3 kW at 208 VAC

Installation Instructions

The Induction Cooktops must connect to a separate, grounded wire, single phase, AC Only electrical supply with their own circuit breaker. These appliances must be installed in accordance with National Electrical Codes, as well as all state, municipal and local codes. This appliance must be supplied with the proper voltage and frequency and amperage, which is protected by a properly sized circuit breaker or time delay fuse.

The cable from appliance is equipped with 3-wires:

If 3-Wire Cable from Home Power Supply

IMPORTANT: Use the 3-wire cable from Home Power Supply where local codes permit a 3-wire connection.

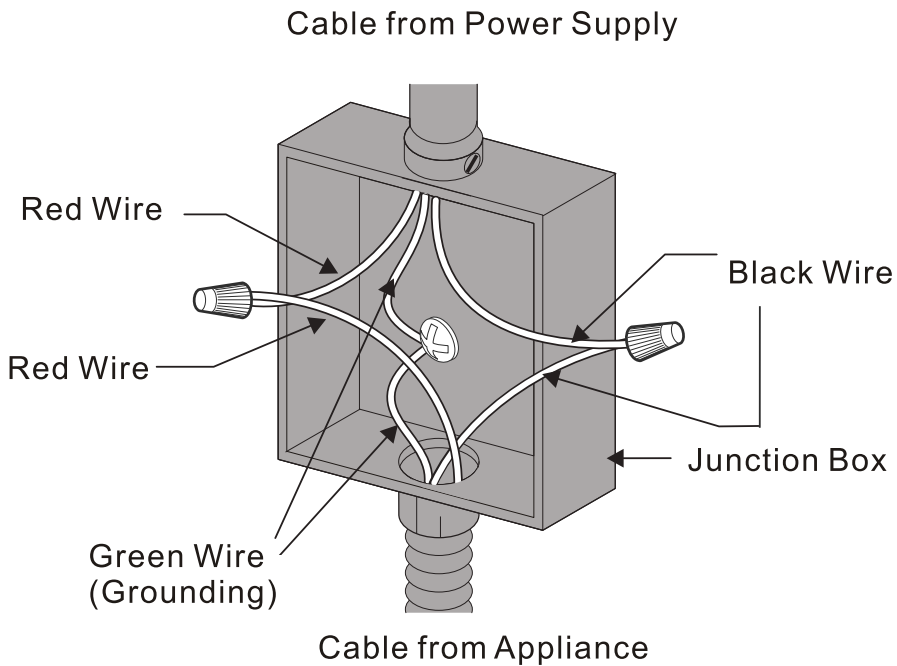

3-Wire Cable from Home Power Supply

If 4-Wire Cable from Home Power Supply

IMPORTANT: Use the 4-wire cable from Home Power Supply where local codes do not allow grounding through neutral.

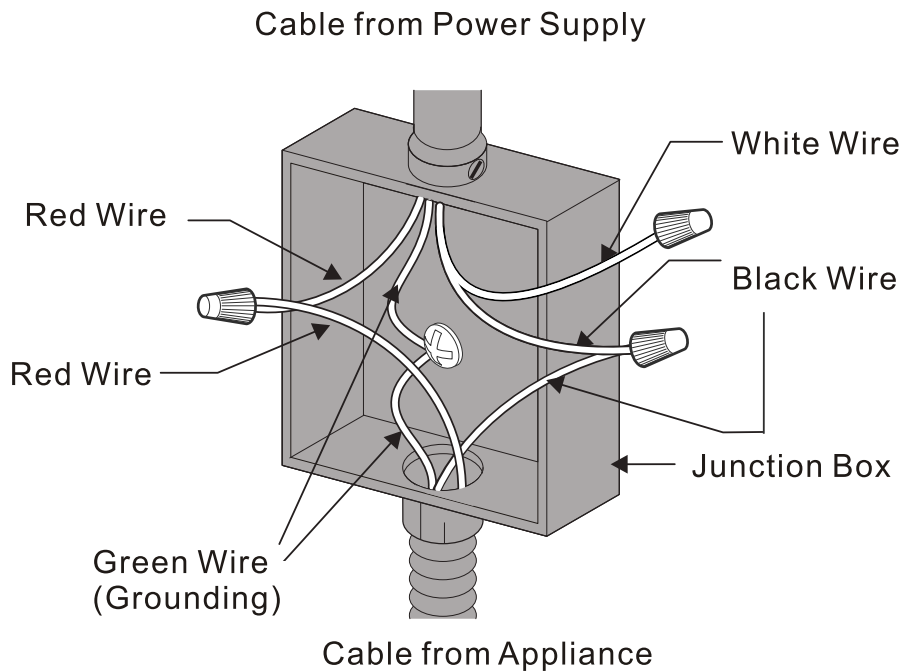

4-Wire Cable from Home Power Supply

Electrical ground is required on this appliance

⚠ WARNING The cooktop conduit wiring is approved for copper wire connection only, if you have aluminum house wiring, use only special connectors which are approved for joining copper and aluminum wires conform with local codes and ordinances. Follow the electrical connector manufacturer's recommended procedure closely.

Installation Instructions

Installation — 30" (76.2cm) Model EMPV-IDC30

Cooktop Dimensions		
A. Width	B. Depth	C. Height
30"(762)	21"(533)	2 1/8"(55)

* DO NOT obstruct these areas.

IMPORTANT: For perfect ventilation, provide a vent of under the countertop, in the front of the cabinet and in the back of the cabinet. The ventilation opening is to extend the full length of the cooktop cutout.

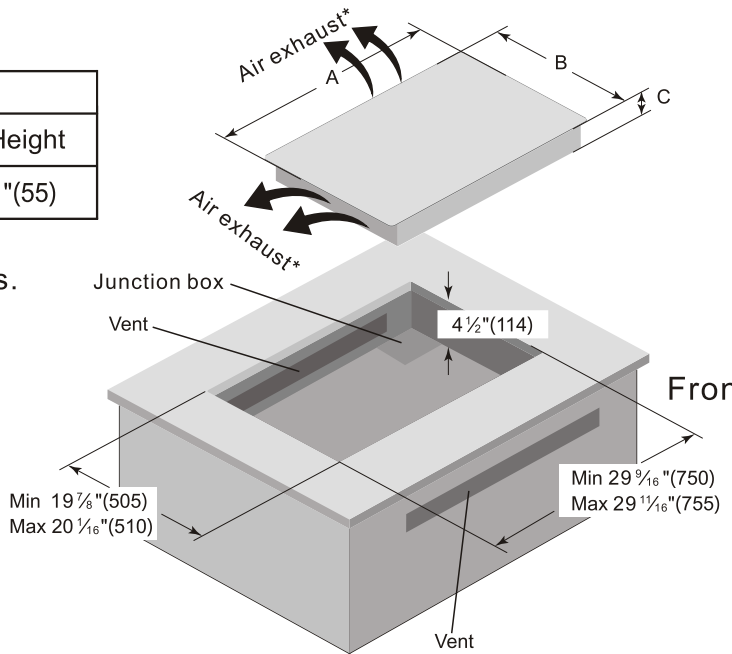

EMPV-IDC30 Cooktop and Cutout Dimension

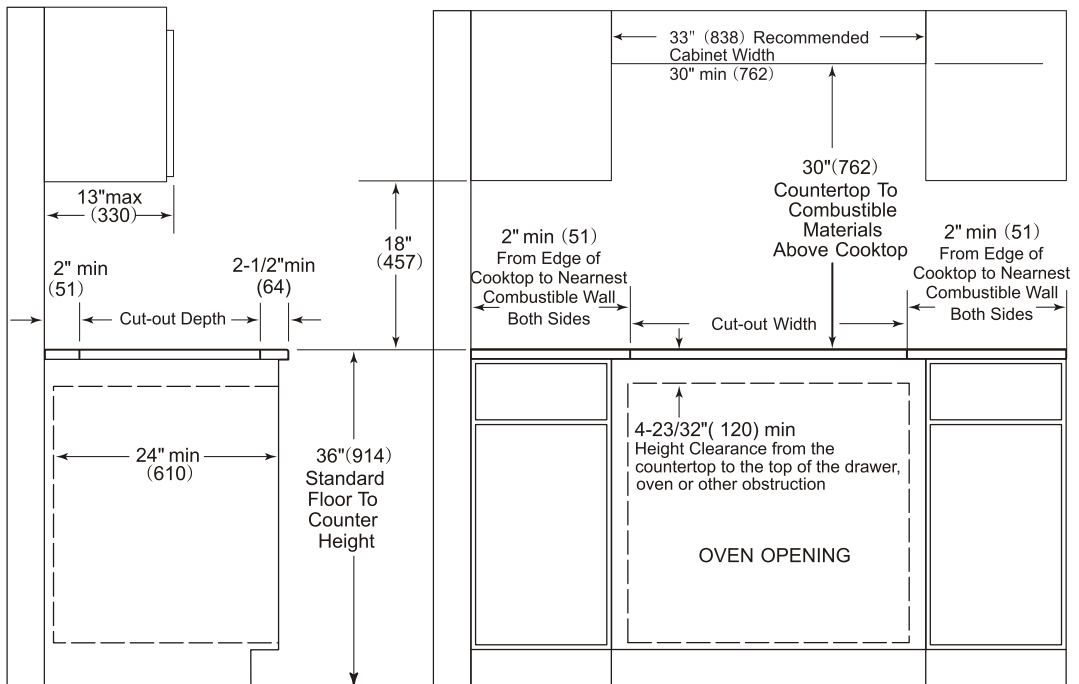

EMPV-IDC30 Countertop Cut-Out Opening

All dimensions are stated in inches and (mm).

Installation Instructions

Installation — 36" (91.4cm) Model EMPV-IDC36

Cooktop Dimensions		
A. Width	B. Depth	C. Height
36"(914)	21"(533)	2 1/8"(55)

* DO NOT obstruct these areas.

IMPORTANT: For perfect ventilation, provide a vent of under the countertop, in the front of the cabinet and in the back of the cabinet. The ventilation opening is to extend the full length of the cooktop cutout.

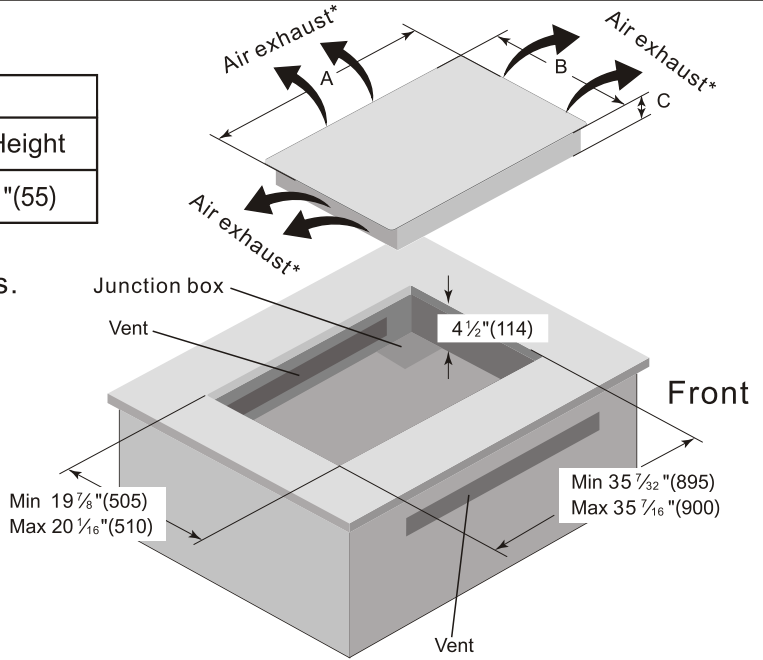

EMPV-IDC36 Cooktop and Cutout Dimension

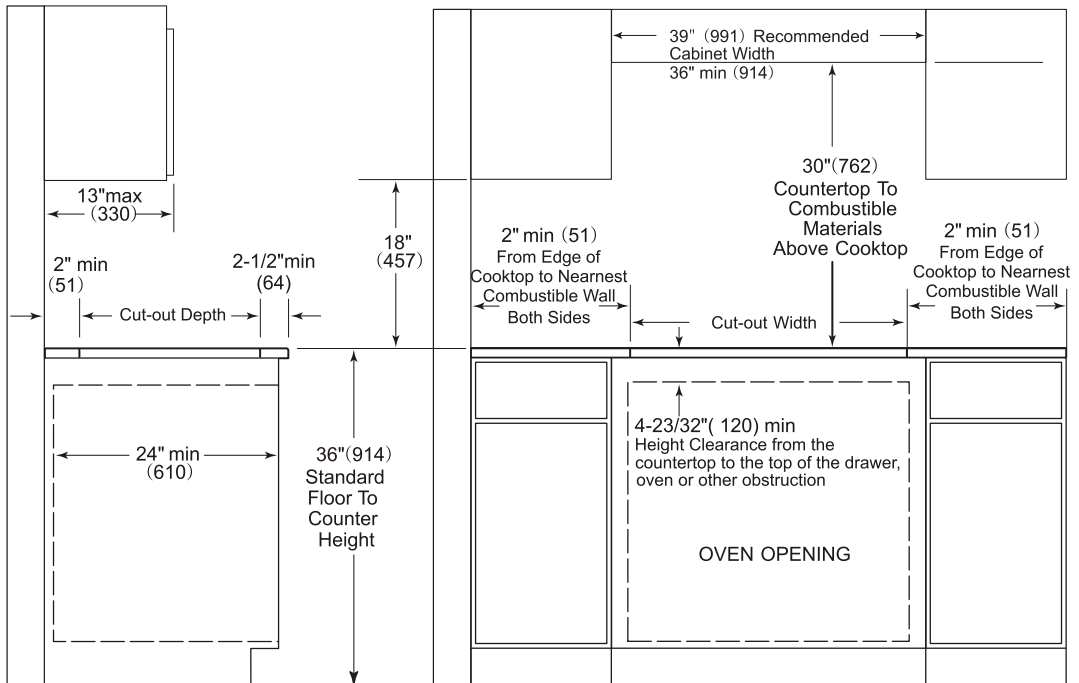

EMPV-IDC36 Countertop Cut-Out Opening

All dimensions are stated in inches and (mm).

Installation Instructions

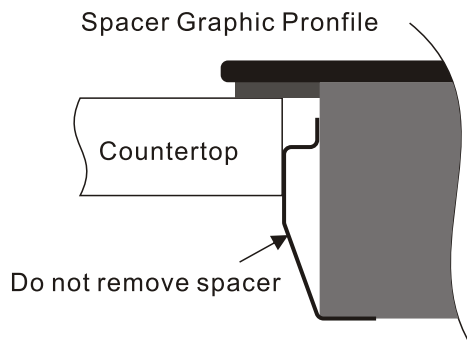
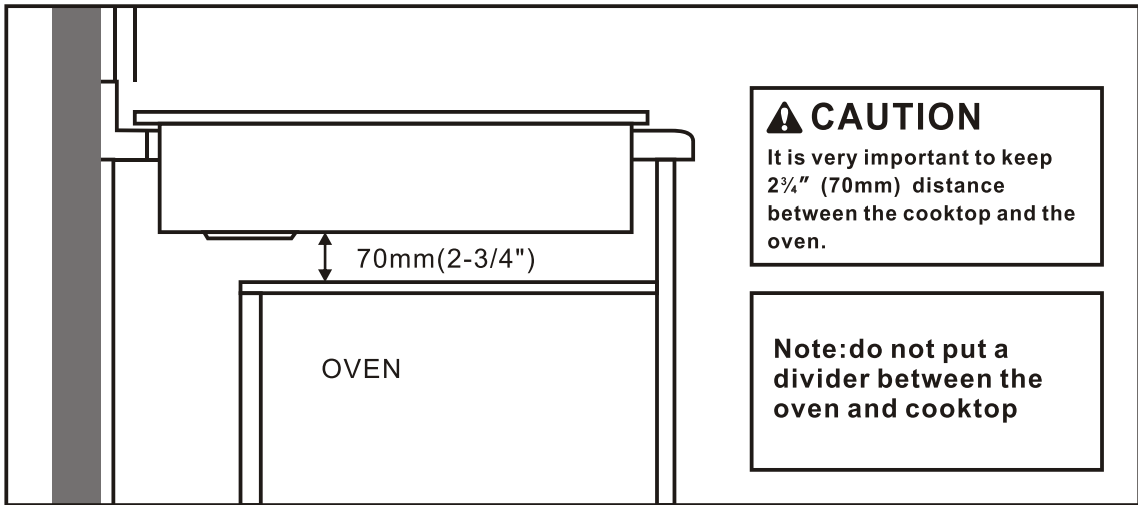

NOTE: The cooktops include spacers on both sides to ensure proper airflow once installed. Do not remove the spacers.

Installation Instructions

After Installation

1. Remove all the stickers and items from the top of the cooktop surface.
2. Clean cooktop before use. Dry with a soft cloth. See **Cleaning Your Cooktop** for reference.
3. Read **Using The Cooktop**.
4. Turn on the power to the cooktop.
5. Verify all function operation properly.

NOTE: If the cooktop does not work, or you met any problem in your operation, please check that the circuit breaker has not tripped or the house has not blown. For more information, please See **Troubleshooting Guide**. If you do not solve the problem by yourself, please call us for assistance or service.