

EMPAVA

SPA

MASSAGE BATHTUB

MODEL: EMPV-67AIS38-BN



Introduction

In order to use our products safely and effectively, please read this instruction carefully. Improper installation, operation and maintenance will cause the damage to the products and charge you extra repairing fee.

- Thank you for you to choose our massage bathtub series;
- We provide a lifetime warranty after-sale service, please fill warranty registration form accurately;
- If you need any help, please contact local distributor or our company directly;
- Our company reserve the right to change all the models listed in this instruction without prior notice;
- This instruction applies to the listed products as below.
- Because of the difference of the market requirement and individual custom product, please refer to the corresponding content in this instruction according to the product and its functions you choose. In this way, you can install and operate the product correctly.

- In order to install the product correctly and safely by the installer, and you can use and maintain this product correctly and safely, please pay much attention to the warning sign as below

The warning symbol's meaning is as below:

	Notice
This symbol indicates that errant handling after disregarding this symbol could result in personal injury or property loss.	

- In order to install, use and maintain this product correctly and safely, please read and understand this instruction totally.
- This instruction is a valuable source of product information to help the end user use the product safely and correctly. Please take good care of it and keep it from getting lost or soiled.

Preparation before installation

- Make sure the place you install the bathtub is strong enough to bear the total weight of bathtub, maximum water volume and the user.
- Waterproofing process must be made in the place of bathtub installed, or down stair will get damaged if water leaks.

- The installed place must equip with water supply, power supply and drainage:
- This product uses universal home power.

	Notice
*External circuitry need to equip with high sensitive and fast type leakage protection switch. (Induced current rating below 15MA, trip time should less than 0.1 second, rated current is above 30A.)	
* The product should be installed the grounding and electric leakage switch by a qualified licensed electrician.	

- Please reserve the drainage hole $\geq \phi 50\text{mm}$, make sure the drainage pipes accord with the water valve.
- User need to reserve the connectors of 1/2" external thread cold/hot water hoses, which outstand the wall 30mm. It is suggested to install a valve in each pipe, the location of installed should be designed by user, which is convenient for maintaining.
- As each bathroom or power and drain of each bathtub is slightly different, please place the bathtub according to the actual situation, the following illustration as a reference layout:

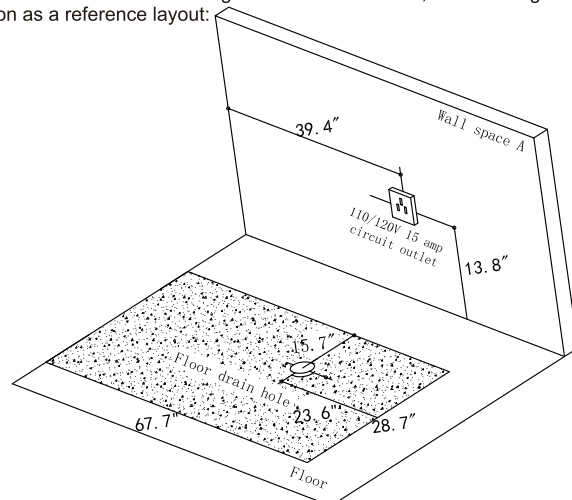

	Notice
The safe distance between power supply and water supply should be not less than 30cm.	

Precautions for installation

- Please check whether all parts are complete. If you have any question, please give feedback to our company in time.
- After opening the box, please immediately dispose of unneeded packaging. Or it may cause the personal injury by the wooden frames, nails, cardboard or sealing straps which are placed carelessly.
- In addition, please do not let the children to play with the packing material. Or it will cause personal injury.
- Parts containing live parts, except parts supplied with safety extra-low voltage not exceeding 12 V, must be inaccessible to a person in the bath
- Earthed appliances must be permanently connected to fixed wiring
- Parts incorporating electrical components, except remote control devices, must be located or fixed so that they cannot fall into the bath
- Please do not use other power, except specified power Or it may cause fire or electric shock.
- Electrical leakage protection switch should be installed outside the bathroom. Or it may cause fire or electric shock.
- Do not use the broken power supply, power plug or the loose socket. Or it may cause fire or electric shock.
- Do not modify the power supply cord, use it with an extension cord or combine it with other equipment using multiple plugs. Doing so could lead to shocks, overheating or fire.
- Please make sure the power plug is waterproof protection with silicon. Or it may cause fire or electric shock by water infiltration.

	Notice
--	---------------

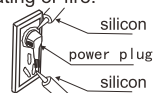

- Before the installation finish, please use cardboard to protect the bathtub or it may lead the damage of the bathtub.
- Do not put the fire on the bathtub, such as a lighted cigarette, or it may lead the damage of the bathtub.
- Do not stand on bathtub while working. Doing so could cause one to slip and fall or could otherwise damage the product.
- Install securely, in accordance with the Installation Manual. Improper installation can lead to water leaks that damage or ruin household property.
- After finish the installation, the product should go into trial operation fully to check the installation is proper or not.

Size chart

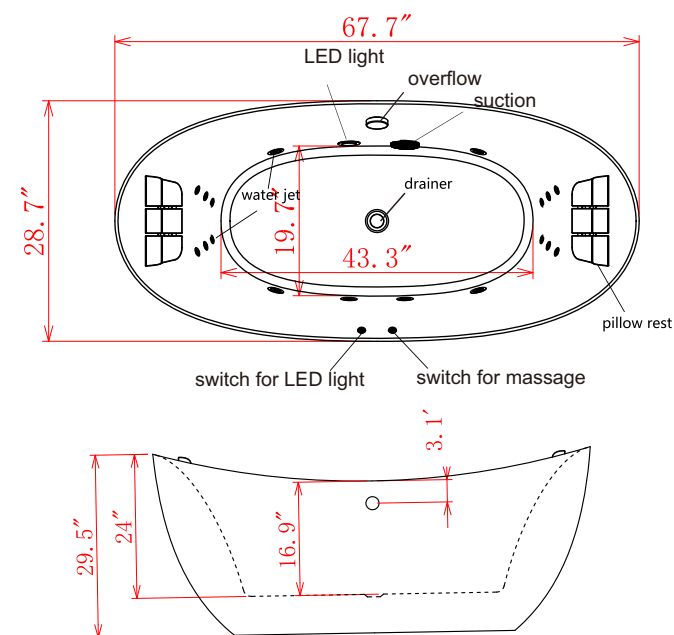

Installation instruction

● Inspection before installation

Although all our massage bathtub are water tested before they leave our factory, there may be some loose of the hose connections due to the transport. We need water test the product before installation. The steps are as follow:

- Place the tub on a flat surface in an area where it may be drained after testing. And adjust the feet to make the bathtub level;
- Check if there is any loose of all the connection system;
- Close the door, fill the tub with water to the overflow and allow standing for 10 minutes to inspect the tub for leaks;
- Insert the plug, start all the function for few minutes (which includes the functions of massage), inspect the tub completely any defect must be reported to your dealer/distributor prior to installation in order to have it covered under warranty.

● Adjust the leveling feet

According to different sizes bathtubs, we design about several leveling feet to adjust the bathtub. Please use a wrench or level ruler to level the bathtub.

- Note: If the bathtub is not level, it may lead :
- noise increased;
 - remaining water in the hoses or the drainage;
 - bathtub shaking;

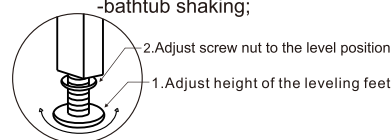

Installation instruction

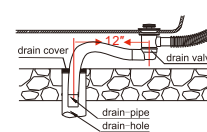

The drain pipe is 31.5" long and the ground drain should be 12" – 20" away from the bathtub drain so that the drainpipe can form an S-bend for odor isolation
Insert the drain-pipe to the drain-hole on the floor, and then cover it with water retaining cover to prevent waste water spilling.

	Notice
Installation requirement: The drain - pipe 's installation slope should be above 1:50 . Operation requirement: When moving the bathtub, don ' t let it crash with hard objects ("it" refers to the bathtub). These standardize product installation and moving to ensure use and component safety.	

● How to connect the electricity?

The bathtub is supplied with a plug which can be inserted into a 110 /120V 15 amp circuit outlet.

Note: This product uses universal home power. External circuitry is equipped with high sensitive and fast type leakage protection switch. (Induced current rating below 15MA; trip time should be less than 0.1 second; rated current is above 30A.)

	Notice
The product should be installed alongside ground and electric leakage switches by a licensed electrician.	

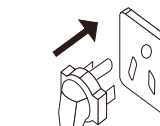

From electrical source 110-120V

Make sure the ground is connected. One side of the ground should be connected to the ground terminal of the motor and the stainless steel frame; the other side should be connected to the ground wires of the plug.

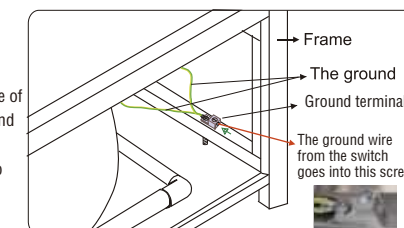

	Notice
The bathtub must be connected to the ground. The power outlet must be sealed well. Make sure the surface of each wire is intact.	

Precautions for use

- This instruction is for the massage bathtub series, not just for a certain model. Please refer to the model and configuration you choose when using the product.
- Use this unit only for its intended use as described in this manual. Do not use attachments not recommended by the manufacturer.
- Children shall not play with the appliance.
- Cleaning and user maintenance shall not be made by children without supervision.
- Do not permit children to use this unit unless an adult closely supervises them at all times. Supervision is also required when an elderly or handicapped individual uses whirlpool bath.
- For the early months of pregnancy, pregnant or possibly pregnant women should limit whirlpool water temperature to 100°F(38°C), because the excessive water temperatures have a high potential for causing fetal damage.
- Person with a medical history of heart disease, low or high blood pressure, circulatory system problems or diabetes should consult a physician before using a whirlpool.
- The use of drugs or alcoholic beverages before or during whirlpool use may lead to unconsciousness with the possibility of drowning.
- The water in a whirlpool should never exceed 104°F(40°C). Water temperatures between 100°F(38°C) and 104°F(40°C) are considered safe for a healthy adult. Use time should be limited to approximately 30 minutes, followed by a shower to cool down. Lower water temperatures are recommended for extended use (exceeding 10-15 minutes) and are definitely recommended for younger children. If you become nauseous, dizzy or develop a headache, get out at once and cool down. Get medical attention if symptoms persist. Check with a physician before using whirlpool again.
- Persons using medication should consult a physician before using a whirlpool since medication may induce drowsiness while other medication may affect heart rate, blood pressure and circulation.
- The thermostatic mixer can maintain the temperature of the water input, please use carefully according to the operating instruction to avoid the scald or catch a cold.
- Do not operate this unit without the suction cover over the suction fitting. This suction cover is a safety device that reduces the potential hazard of hair or body entrapment. Keep hair and body away from suction cover when the pump is running.
- Never drop or insert any object in any opening within the whirlpool.
- Never operate electrically connected devices in or near the bath. No electric appliances should be within 5 feet/1.5 meters of this bathtub (such as hair dryers, lamp, telephone, radio, television and so on.)

	Notice
--	---------------

Advanced computer massage cylinder control system

MODEL: GED-1.0

Installation instruction

1. Product function:

- 1). Underwater light function;
- 2). pump function;
- 3). Water pump water shortage protection function (optional)

2. Technical parameters:

- 1). Power supply: AC90V~240V 50-60Hz
- 2). pump power: AC220V 1500W
- 3). Dielectric strength: 1500V for 1 minute.
- 4). Leakage current: <0.25mA
- 5). Underwater light load: DC12V 10W
- 6). Waterproof level: IPX5

3. Panel function description:

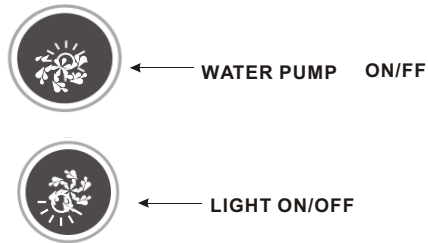

4. Operating instructions:

- Press to turn the water pump on or off.
- Press to turn the light on or off.

5. Schematic diagram of system wiring:

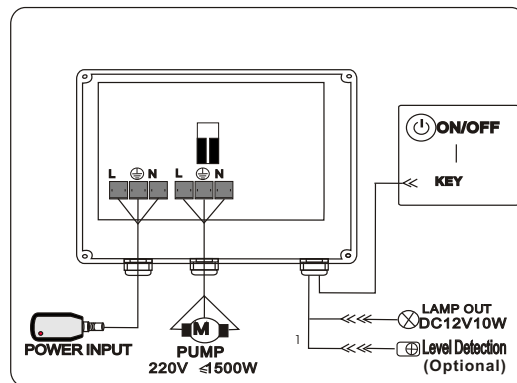

● Water jets use:

Turning the head of water jets up, down, left or right can adjust the angle of inflow.



Small water jets

● Drainage

1. Manual drainage

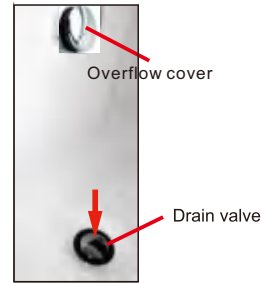

When you get out of the bathtub, step on the drain cover and press it down next time.

When the water is over the maximum water level, the excess water will be drained by overflow.

Care and Maintenance

Regular bathtub maintenance will keep it clean and working at its best. Pump and pipe circulation systems should be flushed before first use and on a monthly basis when product is under normal use. Below is the recommended cleaning procedure:

1. Do not run the jet massage system dry.
2. Fill the tub with hot water (about 40°C) 2-3 cm (0.9-1.2 inch) above the jets. Add 2-3 teaspoons of low foaming detergent, such as dishwashing machine detergent.
3. Turn on all the functions and run for 10 minutes.
4. Drain tub completely.
5. Fill tub with cold water above jets.
6. Turn on all the functions and run for 15 minutes.
7. Drain tub completely.
8. Clean the "suction cover" by removing any hair or lint.

Whirlpool Suction Cover/Strainer

Maintain regular cleaning of the suction cover/strainer

1. Rotate the suction cover to the left to detach it.
2. Remove any hair, lint, or debris present on the cover and housing.
3. Remember to reattach the cover in place.

WARNING! Please orient the cover/strainer with the small notch at the bottom. The gasket must be inserted into the groove of the cover/strainer before mounting it onto the suction fitting.

DANGER: RISK OF SEVERE INJURY OR DROWNING!

- a. Keep hair a minimum of 6 inches (152 mm) away from the suction fitting at all times when the whirlpool system is operating. Individuals with shoulder-length hair should secure it close to their heads or wear a bathing cap.
- b. Do not operate the Whirlpool system with the suction cover/strainer removed! It is a safety device and must always be in place on the suction fitting to minimize the potential hazard of hair and body entrapment.

This bathtub is designed for "fill and drain" use, which means the bathtub needs to be drained after each use and refilled with fresh water for the next bather. This is a health precaution, as these bathtubs are not designed to hold water continuously, like pools or spas. Close the drain and fill the bathtub until water is at least 1" to 2" (25 mm to 51 mm) above the highest jet or air inlet (as indicated by water line in the right diagram). Do not turn on the Whirlpool or Air system at any time if the jets or air inlets are not fully immersed in water. Doing so may cause water to spray outside the bathtub area.

1" -2" above the top jet



Notice

Always implement countermeasures that help prevent freezing. You must empty the bathtub and the water in the pipe during winter use. If the pipes freeze, the pipes could rupture or equipment could become damaged.

Use no water other than standard tap water. The use of well water could cause corrosion, which could lead to leaks.

The bathtub should not be exposed to ultraviolet or bright light, otherwise aging could be accelerated, causing damage.

Keep the bathtub away from cigarette butts, hair dryers, and other heat sources, otherwise the product may be damaged due to high temperature deformation.

When not in use, please keep the bathtub well-ventilated and dry; avoid contact with corrosive substances; cut off electricity and cut off water supply.

To avoid other damage, please do not drop or strike the bathtub with hard objects. Doing so could crack or scratch the bathtub or cause leaks that damage or ruin household property.

When the product is at work, you cannot cut off any connection lines and split the bus master and control panel. Any part of the control panel and the bus master CAN NOT be split by the user. Doing so may cause product leakage, electric shock, or other accidents.

The ground fault circuit interrupter (GFCI) should be tested regularly. It is ideal to test before each use.



Notice

Use water or mild detergent to clean the product. Do not use acids, alkalis, chemical organic solvents, or acidic/alkaline cleaning agents. Otherwise, the bathtub will experience surface damage. When water or a neutral detergent cannot remove stains, use a clean cloth with a little alcohol to remove stains.

Plating parts maintenance: use cotton fabric to scrub.

Light scratches and dulled areas may be restored to original luster by coarse grinding using NO. 1200 waterproof sandpaper dipped in water. Then fine grind by using NO. 2000 waterproof sandpaper dipped in water. Finally, polish with a soft cloth and a polishing agent.

When not in use, please keep the bathtub well-ventilated and dry; avoid contact with corrosive substances; cut off electricity and cut off water supply.

Troubleshooting Guide

PROBLEMS	CAUSES	SOLUTIONS
Pump/motor and jets do not operate	1. No power to pump/motor 2. Water level does not reach high enough 3. Air hose connected to the pneumatic switch is loose 4. Defective Pump/motor	1. Check for power supply and power connections. 2. Inflow water until it reaches the minimum water level of the bathtub 3. Tighten the loose air hose and pneumatic switch connection 4. Contact Empava for WARRANTY & SERVICE
Not all jets are functioning	• Jets are closed	1. Adjust the jets by rotating clockwise/anticlockwise 2. Contact Empava for WARRANTY & SERVICE
Water leakage from pump/motor	1. O ring is pinched or faulty 2. Screw nut is not tightened or connected properly	1. Replace the old ring 2. Tighten the screw nut and make sure it's in good connection 3. Contact Empava for WARRANTY & SERVICE
Water leakage from PVC pipes	The glass glue is not enough	1. Apply glass glue to seal it 2. Contact Empava for WARRANTY & SERVICE
Water leakage from drainage	1. O ring is pinched or faulty 2. Drain pipe is broken	1. Replace the old ring or the drain pipe 2. Replace the drain pipe 3. Contact Empava for WARRANTY & SERVICE
Water leakage from hardware	1. O ring is pinched or faulty 2. Defective control valve	1. Replace the old ring or faucet/showerhead 2. Replace the control valve under knobs 3. Contact Empava for WARRANTY & SERVICE

Empava® APPLIANCES

PROOF OF PURCHASE IS REQUIRED TO OBTAIN WARRANTY SERVICE.

Please have the following information available when you call/ email the Empava Customer Center:

- Proof of purchase (POF or screenshot of order confirmation)
- Model number and serial number
- A clear and comprehensive description of the issue

IF YOU NEED SERVICE: Empava Customer Center
Email: support@empava.com
Address: 458 Parriott PI W
City of Industry, CA, 91745

Website: https://empava.com
Call: 888-682-8882 Monday - Friday from 9am - 5pm PST

Empava® APPLIANCES WARRANTY	
WHAT IS COVERED	WHAT IS NOT COVERED

TWO YEARS WARRANTY (PARTS)

Empava offers a two-year warranty on parts for the following categories: induction cooktop, gas cooktop, electrical oven, pizza oven, fre glass, juicer, range hood, wine cooler, beverage refrigerator and toilet seat

TWO YEARS WARRANTY (PARTS & LABOR)

Empava offers a two-year warranty on both parts and labor for the following categories: gas oven and gas range.

THREE YEARS WARRANTY (PARTS & LABOR)

Empava provides a three-year warranty on both parts and labor for the following categories: freestanding tub, massage tub, and walk-in tub.

This limited warranty is valid for products that are either purchased brand new from an authorized Empava dealer or directly from Empava.

The effective date of the warranty commences from the date of original consumer purchase. If the appliance is installed, operated, and maintained in accordance with the user manual, Empava will provide parts at no cost to rectify any defects in materials and workmanship that were present at the time of purchase. Alternatively, at its sole discretion, Empava may replace the product. In the event of product replacement, the warranty for the replacement product shall be valid for the remaining term of the original warranty period.

1. Commercial, non-residential or multiple-family use, or use inconsistent with published user, operator or installation instructions.
2. In-home Instruction on how to use your product.
3. Service to correct improper product maintenance or installation, installation not in accordance with electrical or plumbing codes or correction of household electrical or plumbing (i.e., house wiring, fuses or water inlet hoses).
4. Defects or damage caused by the use of non-genuine Empava parts or accessories.
5. Conversion of your product from natural gas or L.P. gas.
6. Damage from accident, misuse, abuse, fire, floods, acts of God or use with products not approved by Empava.
7. Repairs to parts or systems to correct product damage or defects caused by unauthorized service, alteration or modification of the appliance.
8. Cosmetic damage including scratches, dents, chips, and other damage to appliance finishes unless such damage results from defects in materials and workmanship and is reported to Empava within 30 days.
9. Discoloration, rust or oxidation of surfaces resulting from caustic or corrosive environments including but not limited to high salt concentrations, high moisture or humidity or exposure to chemicals.
10. Food loss due to product failure.
11. Removal or reinstallation of inaccessible appliances or built-in fixtures (i.e., trim, decorative panels, flooring, cabinetry, islands, countertops, drywall, etc.) that interfere with servicing, removal or replacement of the product.

DISCLAIMER OF IMPLIED WARRANTIES

IMPLIED WARRANTIES, INCLUDING ANY IMPLIED WARRANTY OF MERCHANTABILITY OR IMPLIED WARRANTY OF FITNESS FOR A PARTICULAR PURPOSE, ARE LIMITED TO ONE YEAR OR THE SHORTEST PERIOD ALLOWED BY LAW. Some states and provinces do not allow limitations on the duration of implied warranties of merchantability or fitness, so this limitation may not apply to you. This warranty gives you specific legal rights, and you also may have other rights that vary from state to state or province to province.

DISCLAIMER OF REPRESENTATIONS OUTSIDE OF WARRANTY

If you want a longer or more comprehensive warranty than the limited warranty that comes with this major appliance, you should ask Empava or your retailer about buying an extended warranty.

LIMITATION OF REMEDIES; EXCLUSION OF INCIDENTAL AND CONSEQUENTIAL DAMAGES

HEREIN, EMPAVA SHALL NOT BE LIABLE FOR INCIDENTAL OR CONSEQUENTIAL DAMAGES. Some states and provinces do not allow the exclusion or limitation of incidental or consequential damages, so these limitations and exclusions may not apply to you. This warranty gives you specific legal rights, and you also may have other rights that vary from state to state or province to province.

WARNING!
CALIFORNIA RESIDENTS
Cancer and Reproductive Harm

AVERTISSEMENT!
RÉSIDENTS DE CALIFORNIE
Cancer et Dommages à la Reproduction

¡ADVERTENCIA!
RESIDENTES DE CALIFORNIA
Cáncer y Daño Reproductivo

www.P65W.amngs.ca.gov

EMPAVA APPLIANCES INC.

Add:458 Parriott PI W
City of Industry, CA, 91745
TEL:(888)-682-8882

WWW.EMPAVA.COM